









**IMAGENS GRÁFICAS**

**CABOS**

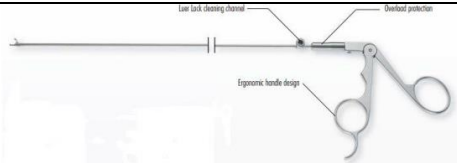

<b>Código</b>	<b>Descrição</b>	<b>Ilustração</b>	<b>Matéria Prima</b>
MP-86214-EH	Cabo D		AÇO INOX ASTM F899
MP-86215-EH	Cabo A		AÇO INOX ASTM F899
MP-86216-EH	Cabo B		AÇO INOX ASTM F899
MP-86217-EH	Cabo C		AÇO INOX ASTM F899

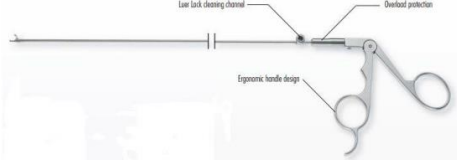



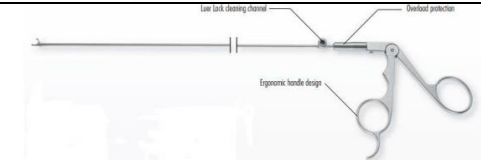
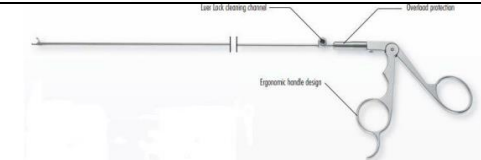

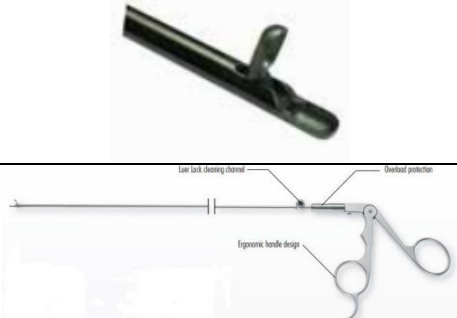
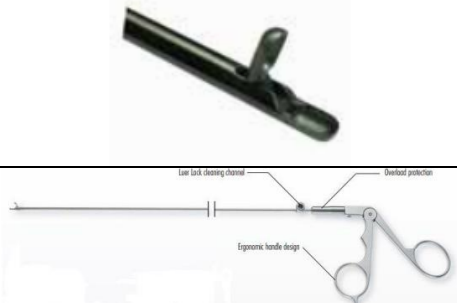
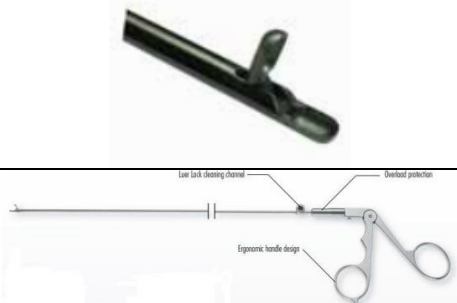
**PINÇA**



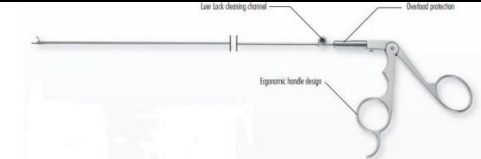

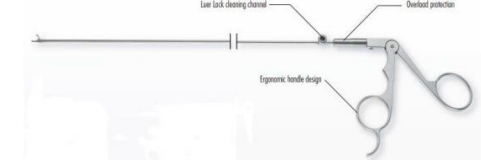

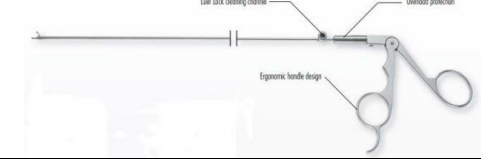
Segue abaixo a ilustração do produto, no qual a variação entre os modelos está nas pontas do instrumental cirúrgico, desenvolvidas em diferentes formatos e dimensões.



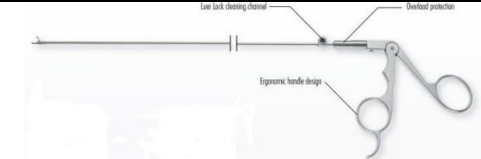

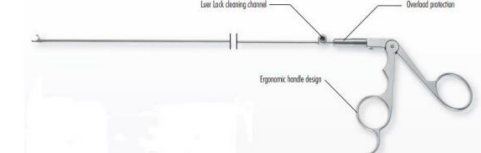

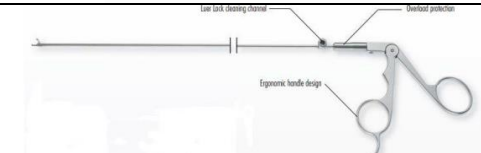
Código	Descrição	Ilustração	Matéria Prima
SPL1-25-35A	Pinça de Colher Cabo A ( colher de mandíbula oval, corte, ação simples) 2,5 x 350 (mm)		AÇO INOX ASTM F899
			
SPL1-30-35A	Pinça de Colher Cabo A ( colher de mandíbula oval, corte, ação simples) 3,0 x 350 (mm)		AÇO INOX ASTM F899
			
SPL1-35-35A	Pinça de Colher Cabo A ( colher de mandíbula oval, corte, ação simples)		AÇO INOX ASTM F899



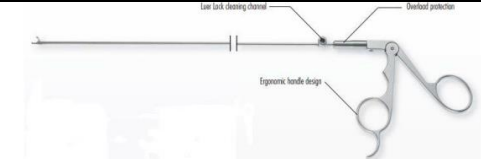

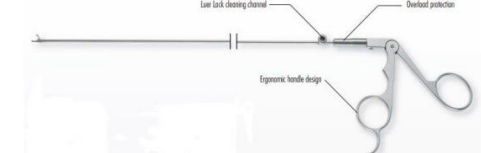

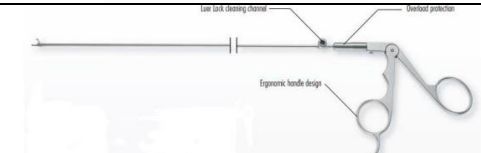
	3,5 x 350 (mm)		
SPL1-25-29A	Pinça de Colher Cabo A ( colher de mandíbula oval, corte, ação simples) 2,5 x 290 (mm)		AÇO INOX ASTM F899
			
SPL1-50-25A	Pinça de Colher Cabo A ( colher de mandíbula oval, corte, ação simples) 5,0 x 250 (mm)		AÇO INOX ASTM F899
			
SPL1-25-35B	Pinça de Colher Cabo B ( colher de mandíbula oval, corte, ação simples) 2,5 x 350 (mm)		AÇO INOX ASTM F899
			



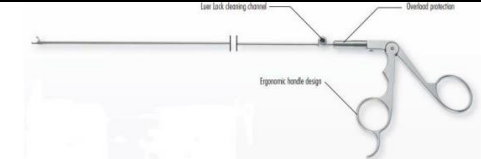

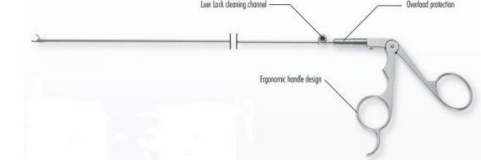

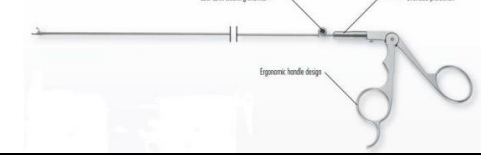
SPL1-30-35B	<p>Pinça de Colher Cabo B ( colher de mandíbula oval, corte, ação simples) 3,0 x 350 (mm)</p>		AÇO INOX ASTM F899
SPL1-35-35B	<p>Pinça de Colher Cabo B ( colher de mandíbula oval, corte, ação simples) 3,5 x 350 (mm)</p>		AÇO INOX ASTM F899
SPL1-25-29B	<p>Pinça de Colher Cabo B ( colher de mandíbula oval, corte, ação simples) 2,5 x 290 (mm)</p>		AÇO INOX ASTM F899
SPL1-50-25B	<p>Pinça de Colher Cabo B ( colher de mandíbula oval, corte, ação simples) 5,0 x 250 (mm)</p>		AÇO INOX ASTM F899



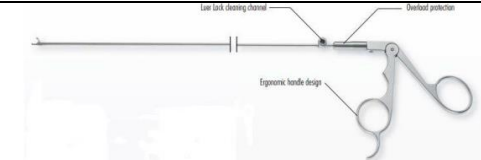

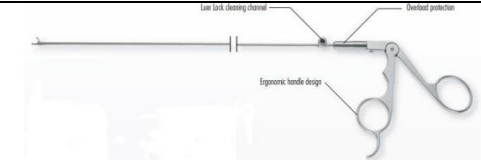

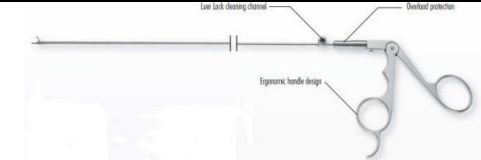
			
SPL1-25-35C	<p>Pinça de Colher Cabo C ( colher de mandíbula oval, corte, ação simples) 2,5 x 350 (mm)</p>		AÇO INOX ASTM F899
			
SPL1-30-35C	<p>Pinça de Colher Cabo C ( colher de mandíbula oval, corte, ação simples) 3,0 x 350 (mm)</p>		AÇO INOX ASTM F899
			
SPL1-35-35C	<p>Pinça de Colher Cabo C ( colher de mandíbula oval, corte, ação simples) 3,5 x 350 (mm)</p>		AÇO INOX ASTM F899



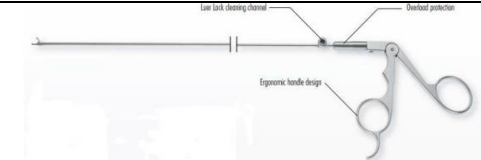

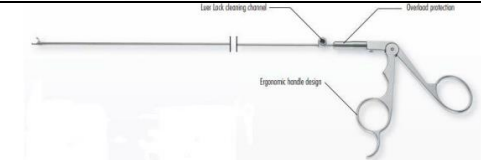

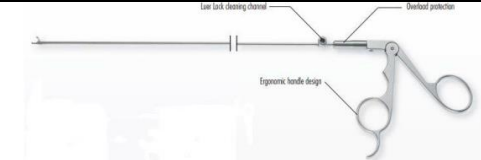
			
SPL1-25-29C	<p>Pinça de Colher Cabo C ( colher de mandíbula oval, corte, ação simples) 2,5 x 290 (mm)</p>		AÇO INOX ASTM F899
			
SPL1-50-25C	<p>Pinça de Colher Cabo C ( colher de mandíbula oval, corte, ação simples) 5,0 x 250 (mm)</p>		AÇO INOX ASTM F899
			
SPL1-25-35D	<p>Pinça de Colher Cabo D ( colher de mandíbula oval, corte, ação simples) 2,5 x 350 (mm)</p>		AÇO INOX ASTM F899



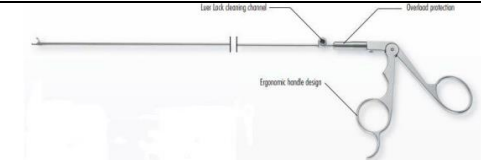

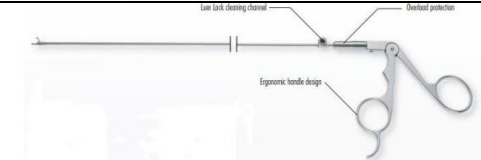

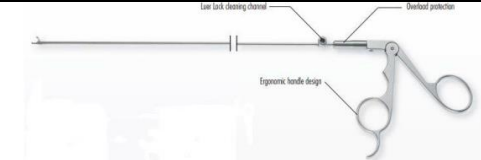
			
SPL1-30-35D	<p>Pinça de Colher Cabo D ( colher de mandíbula oval, corte, ação simples) 3,0 x 350 (mm)</p>		AÇO INOX ASTM F899
			
SPL1-35-35D	<p>Pinça de Colher Cabo D ( colher de mandíbula oval, corte, ação simples) 3,5 x 350 (mm)</p>		AÇO INOX ASTM F899
			
SPL1-25-29D	<p>Pinça de Colher Cabo D ( colher de mandíbula oval, corte, ação simples) 2,5 x 290 (mm)</p>		AÇO INOX ASTM F899



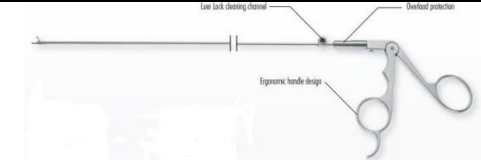

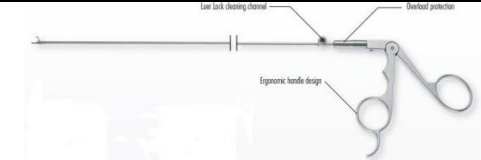

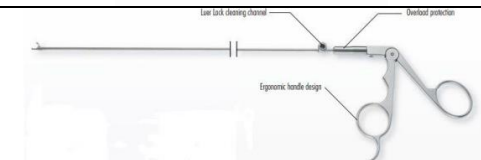
			
SPL1-50-25D	<p>Pinça de Colher Cabo D ( colher de mandíbula oval, corte, ação simples) 5,0 x 250 (mm)</p>		AÇO INOX ASTM F899
			
SPL2-25-35A	<p>Pinça de Colher Cabo A ( colher de mandíbula redonda, corte, ação simples) 2,5 x 350 (mm)</p>		AÇO INOX ASTM F899
			
SPL2-25-29A	<p>Pinça de Colher Cabo A ( colher de mandíbula redonda, corte, ação simples) 2,5 x 290 (mm)</p>		AÇO INOX ASTM F899



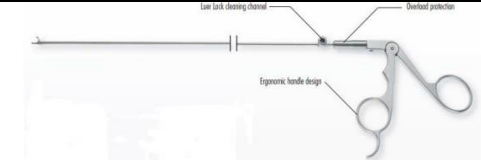

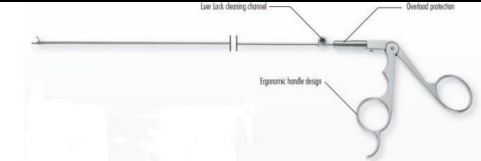

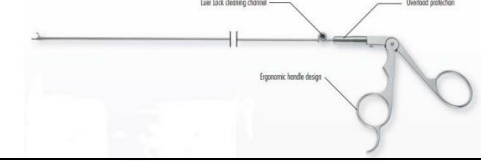
			
SPL2-35-35A	<p>Pinça de Colher Cabo A ( colher de mandíbula redonda, corte, ação simples) 3,5 x 350 (mm)</p>		AÇO INOX ASTM F899
			
SPL2-25-35B	<p>Pinça de Colher Cabo B ( colher de mandíbula redonda, corte, ação simples) 2,5 x 350 (mm)</p>		AÇO INOX ASTM F899
			
SPL2-25-29B	<p>Pinça de Colher Cabo B ( colher de mandíbula redonda, corte, ação simples) 2,5 x 290 (mm)</p>		AÇO INOX ASTM F899



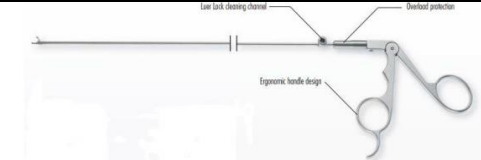

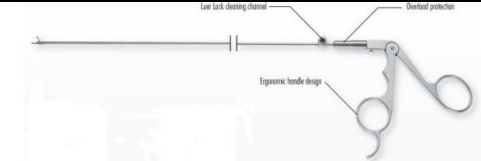

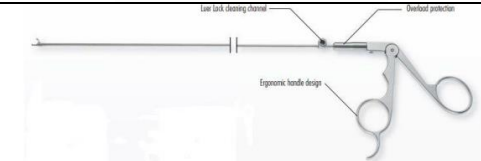
			
SPL2-35-35B	<p>Pinça de Colher Cabo B ( colher de mandíbula redonda, corte, ação simples) 3,5 x 350 (mm)</p>		AÇO INOX ASTM F899
			
SPL2-25-35C	<p>Pinça de Colher Cabo C ( colher de mandíbula redonda, corte, ação simples) 2,5 x 350 (mm)</p>		AÇO INOX ASTM F899
			
SPL2-25-29C	<p>Pinça de Colher Cabo C ( colher de mandíbula redonda, corte, ação simples) 2,5 x 290 (mm)</p>		AÇO INOX ASTM F899



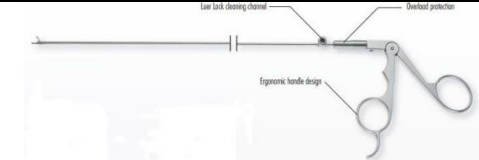

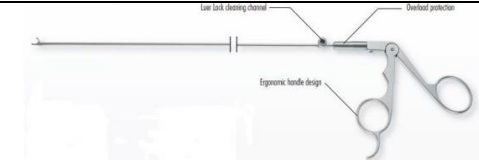

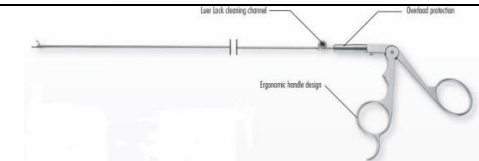
			
SPL2-35-35C	<p>Pinça de Colher Cabo C ( colher de mandíbula redonda, corte, ação simples) 3,5 x 350 (mm)</p>		AÇO INOX ASTM F899
			
SPL2-25-35D	<p>Pinça de Colher Cabo D ( colher de mandíbula redonda, corte, ação simples) 2,5 x 350 (mm)</p>		AÇO INOX ASTM F899
			
SPL2-25-29D	<p>Pinça de Colher Cabo D ( colher de mandíbula redonda, corte, ação simples) 2,5 x 290 (mm)</p>		AÇO INOX ASTM F899



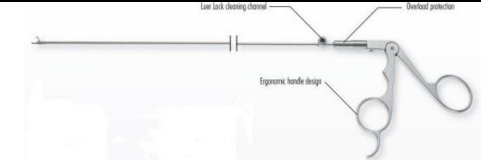

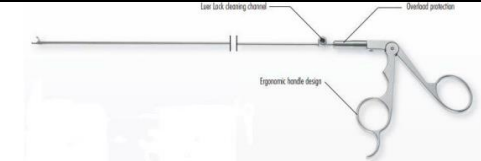

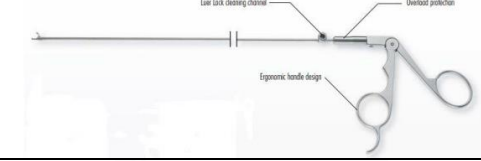
			
SPL2-35-35D	<p>Pinça de Colher Cabo D ( colher de mandíbula redonda, corte, ação simples) 3,5 x 350 (mm)</p>	 	AÇO INOX ASTM F899
SPL3-20-35A	<p>Pinça de Colher Cabo A ( colher de mandíbula redonda, 45º para cima, corte, ação simples) 2,0 x 350 (mm)</p>	 	AÇO INOX ASTM F899
SPL3-20-29A	<p>Pinça de Colher Cabo A ( colher de mandíbula redonda, 45º para cima, corte, ação simples) 2,0 x 290 (mm)</p>		AÇO INOX ASTM F899



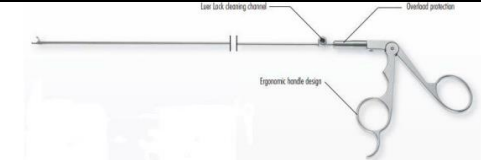

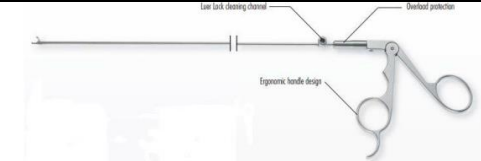

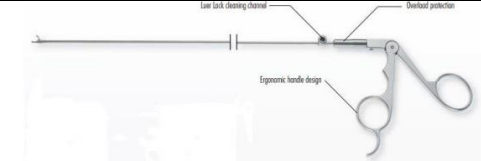
			
SPL3-25-35A	<p>Pinça de Colher Cabo A ( colher de mandíbula redonda, 45º para cima, corte, ação simples) 2,5 x 350 (mm)</p>		AÇO INOX ASTM F899
			
SPL3-25-29A	<p>Pinça de Colher Cabo A ( colher de mandíbula redonda, 45º para cima, corte, ação simples) 2,5 x 290 (mm)</p>		AÇO INOX ASTM F899
			
SPL3-20-35B	<p>Pinça de Colher Cabo B ( colher de mandíbula redonda, 45º para cima, corte, ação simples) 2,0 x 350 (mm)</p>		AÇO INOX ASTM F899



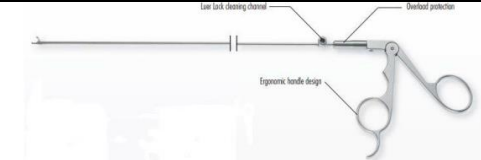

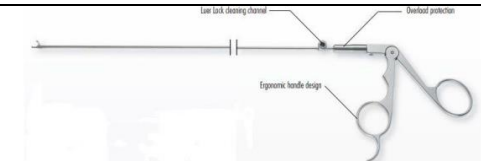

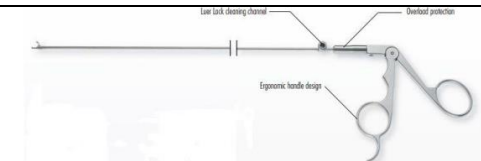
			
SPL3-20-29B	<p>Pinça de Colher Cabo B ( colher de mandíbula redonda, 45º para cima, corte, ação simples) 2,0 x 290 (mm)</p>		AÇO INOX ASTM F899
			
SPL3-25-35B	<p>Pinça de Colher Cabo B ( colher de mandíbula redonda, 45º para cima, corte, ação simples) 2,5 x 350 (mm)</p>		AÇO INOX ASTM F899
			
SPL3-25-29B	<p>Pinça de Colher Cabo B ( colher de mandíbula redonda, 45º para cima, corte, ação simples) 2,5 x 290 (mm)</p>		AÇO INOX ASTM F899

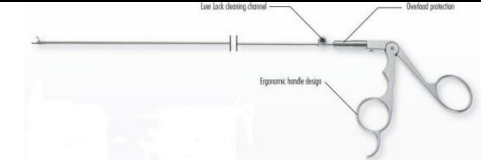

			
SPL3-20-35C	<p>Pinça de Colher Cabo C ( colher de mandíbula redonda, 45º para cima, corte, ação simples) 2,0 x 350 (mm)</p>		AÇO INOX ASTM F899
			
SPL3-20-29C	<p>Pinça de Colher Cabo C ( colher de mandíbula redonda, 45º para cima, corte, ação simples) 2,0 x 290 (mm)</p>		AÇO INOX ASTM F899
			
SPL3-25-35C	<p>Pinça de Colher Cabo C ( colher de mandíbula redonda, 45º para cima, corte, ação simples) 2,5 x 350 (mm)</p>		AÇO INOX ASTM F899

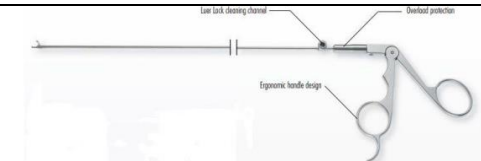
			
SPL3-25-29C	<p>Pinça de Colher Cabo C ( colher de mandíbula redonda, 45º para cima, corte, ação simples) 2,5 x 290 (mm)</p>		AÇO INOX ASTM F899
			
SPL3-20-35D	<p>Pinça de Colher Cabo D ( colher de mandíbula redonda, 45º para cima, corte, ação simples) 2,0 x 350 (mm)</p>		AÇO INOX ASTM F899
			
SPL3-20-29D	<p>Pinça de Colher Cabo D ( colher de mandíbula redonda, 45º para cima, corte, ação simples) 2,0 x 290 (mm)</p>		AÇO INOX ASTM F899

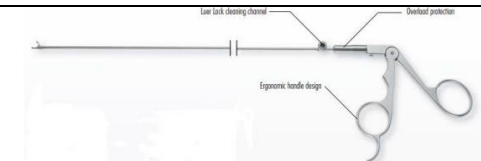

			
SPL3-25-35D	<p>Pinça de Colher Cabo D ( colher de mandíbula redonda, 45º para cima, corte, ação simples) 2,5 x 350 (mm)</p>		AÇO INOX ASTM F899
			
SPL3-25-29D	<p>Pinça de Colher Cabo D ( colher de mandíbula redonda, 45º para cima, corte, ação simples) 2,5 x 290 (mm)</p>		AÇO INOX ASTM F899
			
SPL4-25-33A	<p>Pinça de Colher Cabo A ( colher de mandíbula tipo Blakesley, ação simples) 2,5 x 330 (mm)</p>		AÇO INOX ASTM F899

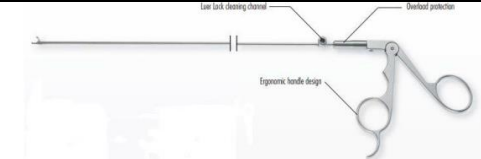

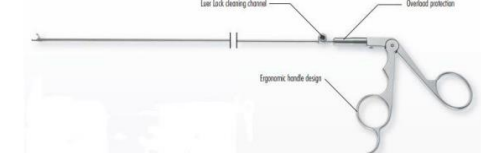



			
SPL4-35-33A	<p>Pinça de Colher Cabo A ( colher de mandíbula tipo Blakesley, ação simples)</p> <p>3,5 x 330 (mm)</p>		AÇO INOX ASTM F899
			
SPL4-25-33B	<p>Pinça de Colher Cabo B ( colher de mandíbula tipo Blakesley, ação simples)</p> <p>2,5 x 330 (mm)</p>		AÇO INOX ASTM F899
			
SPL4-35-33B	<p>Pinça de Colher Cabo B ( colher de mandíbula tipo Blakesley, ação simples)</p> <p>3,5 x 330 (mm)</p>		AÇO INOX ASTM F899







			
SPL4-25-33C	<p>Pinça de Colher Cabo C ( colher de mandíbula tipo Blakesley, ação simples)</p> <p>2,5 x 330 (mm)</p>	 	AÇO INOX ASTM F899
SPL4-35-33C	<p>Pinça de Colher Cabo C ( colher de mandíbula tipo Blakesley, ação simples)</p> <p>3,5 x 330 (mm)</p>	 	AÇO INOX ASTM F899
SPL4-25-33D	<p>Pinça de Colher Cabo D ( colher de mandíbula tipo Blakesley, ação simples)</p> <p>2,5 x 330 (mm)</p>		AÇO INOX ASTM F899







			
SPL4-35-33D	<p>Pinça de Colher Cabo D ( colher de mandíbula tipo Blakesley, ação simples)</p> <p>3,5 x 330 (mm)</p>		AÇO INOX ASTM F899
			







**Fórceps Colher (Peça Completa, Cabo e Haste com ASTM B488)**







SPL1-25-35AGH	<p>Pinça de colher Cabo A com ASTM B488 ( Colher com Mandíbula Oval, Corte, Ação Única)</p> <p>2,5 x 350 (mm)</p>		AÇO INOX ASTM F899 e ASTM B488
			
SPL1-30-35AGH	<p>Pinça de colher Cabo A com ASTM B488 ( Colher com Mandíbula Oval, Corte, Ação Única)</p>		AÇO INOX ASTM F899 e ASTM B488







	3,0 x 350 (mm)		
SPL1-35-35AGH	Pinça de colher Cabo A com ASTM B488 ( Colher com Mandíbula Oval, Corte, Ação Única)		AÇO INOX ASTM F899 e ASTM B488
	3,5 x 350 (mm)		
SPL1-25-29AGH	Pinça de colher Cabo A com ASTM B488 ( Colher com Mandíbula Oval, Corte, Ação Única)		AÇO INOX ASTM F899 e ASTM B488
	2,5 x 290 (mm)		
SPL1-50-25AGH	Pinça de colher Cabo A com ASTM B488 ( Colher com Mandíbula Oval, Corte, Ação Única)		AÇO INOX ASTM F899 e ASTM B488
	5,0 x 250 (mm)		





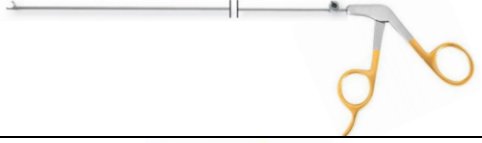

SPL1-25-35BGH	<p>Pinça de colher Cabo B com ASTM B488 ( Colher com Mandíbula Oval, Corte, Aço Única)</p> <p>2,5 x 350 (mm)</p>	 	AÇO INOX ASTM F899 e ASTM B488
SPL1-30-35BGH	<p>Pinça de colher Cabo B com ASTM B488 ( Colher com Mandíbula Oval, Corte, Aço Única)</p> <p>3,0 x 350 (mm)</p>	 	AÇO INOX ASTM F899 e ASTM B488
SPL1-35-35BGH	<p>Pinça de colher Cabo B com ASTM B488 ( Colher com Mandíbula Oval, Corte, Aço Única)</p> <p>3,5 x 350 (mm)</p>	 	AÇO INOX ASTM F899 e ASTM B488
SPL1-25-29BGH	<p>Pinça de colher Cabo B com ASTM B488 ( Colher com Mandíbula Oval, Corte, Aço Única)</p>		AÇO INOX ASTM F899 e ASTM B488





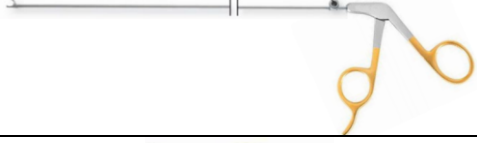

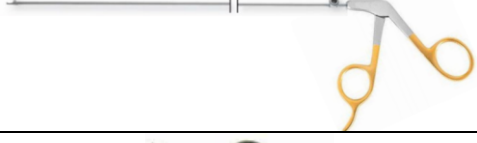

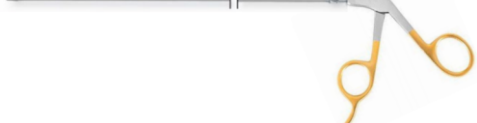
	2,5 x 290 (mm)		
SPL1-50-25BGH	Pinça de colher Cabo B com ASTM B488 ( Colher com Mandíbula Oval, Corte, Ação Única)		AÇO INOX ASTM F899 e ASTM B488
	5,0 x 250 (mm)		
SPL1-25-35CGH	Pinça de colher Cabo C com ASTM B488 ( Colher com Mandíbula Oval, Corte, Ação Única)		AÇO INOX ASTM F899 e ASTM B488
	2,5 x 350 (mm)		
SPL1-30-35CGH	Pinça de colher Cabo C com ASTM B488 ( Colher com Mandíbula Oval, Corte, Ação Única)		AÇO INOX ASTM F899 e ASTM B488
	3,0 x 350 (mm)		







SPL1-35-35CGH	<p>Pinça de colher Cabo C com ASTM B488 ( Colher com Mandíbula Oval, Corte, Aço Única)</p> <p>3,5 x 350 (mm)</p>	 	<p>AÇO INOX ASTM F899 e ASTM B488</p>
SPL1-25-29CGH	<p>Pinça de colher Cabo C com ASTM B488 ( Colher com Mandíbula Oval, Corte, Aço Única)</p> <p>2,5 x 290 (mm)</p>	 	<p>AÇO INOX ASTM F899 e ASTM B488</p>
SPL1-50-25CGH	<p>Pinça de colher Cabo C com ASTM B488 ( Colher com Mandíbula Oval, Corte, Aço Única)</p> <p>5,0 x 250 (mm)</p>	 	<p>AÇO INOX ASTM F899 e ASTM B488</p>
SPL1-25-35DGH	<p>Pinça de colher Cabo D com ASTM B488 ( Colher com Mandíbula Oval, Corte, Aço Única)</p>		<p>AÇO INOX ASTM F899 e ASTM B488</p>

	2,5 x 350 (mm)		
SPL1-30-35DGH	Pinça de colher Cabo D com ASTM B488 ( Colher com Mandíbula Oval, Corte, Ação Única)		AÇO INOX ASTM F899 e ASTM B488
	3,0 x 350 (mm)		
SPL1-35-35DGH	Pinça de colher Cabo D com ASTM B488 ( Colher com Mandíbula Oval, Corte, Ação Única)		AÇO INOX ASTM F899 e ASTM B488
	3,5 x 350 (mm)		
SPL1-25-29DGH	Pinça de colher Cabo D com ASTM B488 ( Colher com Mandíbula Oval, Corte, Ação Única)		AÇO INOX ASTM F899 e ASTM B488
	2,5 x 290 (mm)		





SPL1-50-25DGH	<p>Pinça de colher Cabo D com ASTM B488 ( Colher com Mandíbula Oval, Corte, Ação Única)</p> <p>5,0 x 250 (mm)</p>	 	<p>AÇO INOX ASTM F899 e ASTM B488</p>
SPL2-25-35AGH	<p>Pinça de colher Cabo A com ASTM B488 ( Colher com mordente redondo, corte, ação única)</p> <p>2,5 x 350 (mm)</p>	 	<p>AÇO INOX ASTM F899 e ASTM B488</p>
SPL2-25-29AGH	<p>Pinça de colher Cabo A com ASTM B488 ( Colher com mordente redondo, corte, ação única)</p> <p>2,5 x 290 (mm)</p>	 	<p>AÇO INOX ASTM F899 e ASTM B488</p>
SPL2-35-35AGH	<p>Pinça de colher Cabo A com ASTM B488 ( Colher com mordente redondo, corte, ação única)</p> <p>3,5 x 350 (mm)</p>	 	<p>AÇO INOX ASTM F899 e ASTM B488</p>







SPL2-25-35BGH	Pinça de colher Cabo B com ASTM B488 ( Colher com mordente redondo, corte, ação única)		AÇO INOX ASTM F899 e ASTM B488
	2,5 x 350 (mm)		
SPL2-25-29BGH	Pinça de colher Cabo B com ASTM B488 ( Colher com mordente redondo, corte, ação única)		AÇO INOX ASTM F899 e ASTM B488
	2,5 x 290 (mm)		
SPL2-35-35BGH	Pinça de colher Cabo B com ASTM B488 ( Colher com mordente redondo, corte, ação única)		AÇO INOX ASTM F899 e ASTM B488
	3,5 x 350 (mm)		
SPL2-25-35CGH	Pinça de colher Cabo C com ASTM B488 ( Colher com mordente redondo, corte, ação única)		AÇO INOX ASTM F899 e ASTM B488
	2,5 x 350 (mm)		







SPL2-25-29CGH	Pinça de colher Cabo C com ASTM B488 ( Colher com mordente redondo, corte, ação única)		AÇO INOX ASTM F899 e ASTM B488
	2,5 x 290 (mm)		
SPL2-35-35CGH	Pinça de colher Cabo C com ASTM B488 ( Colher com mordente redondo, corte, ação única)		AÇO INOX ASTM F899 e ASTM B488
	3,5 x 350 (mm)		
SPL2-25-35DGH	Pinça de colher Cabo D com ASTM B488 ( Colher com mordente redondo, corte, ação única)		AÇO INOX ASTM F899 e ASTM B488
	2,5 x 350 (mm)		
SPL2-25-29DGH	Pinça de colher Cabo D com ASTM B488 ( Colher com mordente redondo, corte, ação única)		AÇO INOX ASTM F899 e ASTM B488
	2,5 x 290 (mm)		







SPL2-35-35DGH	<p>Pinça de colher Cabo D com ASTM B488 ( Colher com mordente redondo, corte, ação única)</p> <p>3,5 x 350 (mm)</p>	 	<p>AÇO INOX ASTM F899 e ASTM B488</p>
SPL3-20-35AGH	<p>Pinça de colher Cabo A com ASTM B488 ( Colher com mordente redondo, 45° para cima, corte, ação única)</p> <p>2,0 x 350 (mm)</p>	 	<p>AÇO INOX ASTM F899 e ASTM B488</p>
SPL3-20-29AGH	<p>Pinça de colher Cabo A com ASTM B488 ( Colher com mordente redondo, 45° para cima, corte, ação única)</p> <p>2,0 x 290 (mm)</p>	 	<p>AÇO INOX ASTM F899 e ASTM B488</p>
SPL3-25-35AGH	<p>Pinça de colher Cabo A com ASTM B488 ( Colher com mordente redondo, 45° para cima, corte, ação única)</p>		<p>AÇO INOX ASTM F899 e ASTM B488</p>



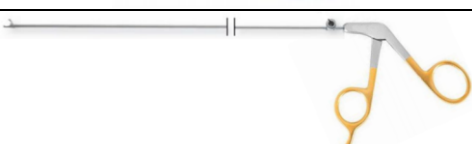

	2,5 x 350 (mm)		
SPL3-25-29AGH	Pinça de colher Cabo A com ASTM B488 ( Colher com mordente redondo, 45° para cima, corte, ação única)		AÇO INOX ASTM F899 e ASTM B488
	2,5 x 290 (mm)		
SPL3-20-35BGH	Pinça de colher Cabo B com ASTM B488 ( Colher com mordente redondo, 45° para cima, corte, ação única)		AÇO INOX ASTM F899 e ASTM B488
	2,0 x 350 (mm)		
SPL3-20-29BGH	Pinça de colher Cabo B com ASTM B488 ( Colher com mordente redondo, 45° para cima, corte, ação única)		AÇO INOX ASTM F899 e ASTM B488
	2,0 x 290 (mm)		

SPL3-25-35BGH	<p>Pinça de colher Cabo B com ASTM B488 ( Colher com mordente redondo, 45° para cima, corte, ação única)</p> <p>2,5 x 350 (mm)</p>		<p>AÇO INOX ASTM F899 e ASTM B488</p>
SPL3-25-29BGH	<p>Pinça de colher Cabo B com ASTM B488 ( Colher com mordente redondo, 45° para cima, corte, ação única)</p> <p>2,5 x 290 (mm)</p>		<p>AÇO INOX ASTM F899 e ASTM B488</p>
SPL3-20-35CGH	<p>Pinça de colher Cabo C com ASTM B488 ( Colher com mordente redondo, 45° para cima, corte, ação única)</p> <p>2,0 x 350 (mm)</p>		<p>AÇO INOX ASTM F899 e ASTM B488</p>
SPL3-20-29CGH	<p>Pinça de colher Cabo C com ASTM B488 ( Colher com mordente redondo, 45° para cima, corte, ação única)</p>		<p>AÇO INOX ASTM F899 e ASTM B488</p>

	2,0 x 290 (mm)		
SPL3-25-35CGH	Pinça de colher Cabo C com ASTM B488 ( Colher com mordente redondo, 45° para cima, corte, ação única)		AÇO INOX ASTM F899 e ASTM B488
	2,5 x 350 (mm)		
SPL3-25-29CGH	Pinça de colher Cabo C com ASTM B488 ( Colher com mordente redondo, 45° para cima, corte, ação única)		AÇO INOX ASTM F899 e ASTM B488
	2,5 x 290 (mm)		
SPL3-20-35DGH	Pinça de colher Cabo D com ASTM B488 ( Colher com mordente redondo, 45° para cima, corte, ação única)		AÇO INOX ASTM F899 e ASTM B488
	2,0 x 350 (mm)		





SPL3-20-29DGH	<p>Pinça de colher Cabo D com ASTM B488 ( Colher com mordente redondo, 45° para cima, corte, ação única)</p>		<p>AÇO INOX ASTM F899 e ASTM B488</p>
	<p>2,0 x 290 (mm)</p>		
SPL3-25-35DGH	<p>Pinça de colher Cabo D com ASTM B488 ( Colher com mordente redondo, 45° para cima, corte, ação única)</p>		<p>AÇO INOX ASTM F899 e ASTM B488</p>
	<p>2,5 x 350 (mm)</p>		
SPL3-25-29DGH	<p>Pinça de colher Cabo D com ASTM B488 ( Colher com mordente redondo, 45° para cima, corte, ação única)</p>		<p>AÇO INOX ASTM F899 e ASTM B488</p>
	<p>2,5 x 290 (mm)</p>		
SPL4-25-33AGH	<p>Pinça de colher Cabo A com ASTM B488 ( Colher tipo Blakesley, ação única)</p>		<p>AÇO INOX ASTM F899 e ASTM B488</p>
	<p>2,5 x 330 (mm)</p>		





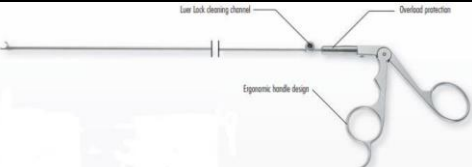

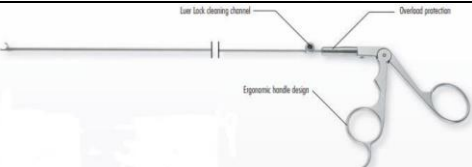
			
SPL4-35-33AGH	<p>Pinça de colher Cabo A com ASTM B488 ( Colher tipo Blakesley, ação única)</p> <p>3,5 x 330 (mm)</p>	 	<p>AÇO INOX ASTM F899 e ASTM B488</p>
SPL4-25-33BGH	<p>Pinça de colher Cabo B com ASTM B488 ( Colher tipo Blakesley, ação única)</p> <p>2,5 x 330 (mm)</p>	 	<p>AÇO INOX ASTM F899 e ASTM B488</p>
SPL4-35-33BGH	<p>Pinça de colher Cabo B com ASTM B488 ( Colher tipo Blakesley, ação única)</p> <p>3,5 x 330 (mm)</p>	 	<p>AÇO INOX ASTM F899 e ASTM B488</p>



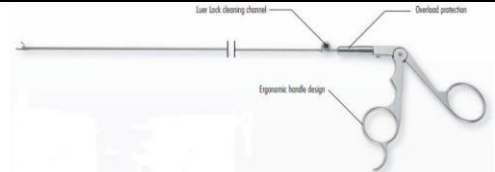

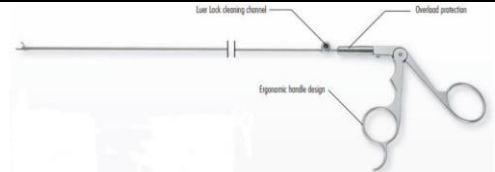

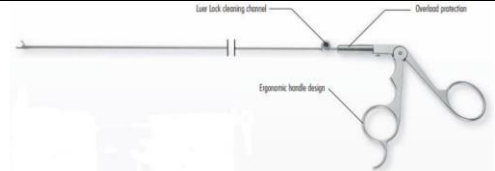
SPL4-25-33CGH	<p>Pinça de colher Cabo C com ASTM B488 ( Colher tipo Blakesley, ação única)</p> <p>2,5 x 330 (mm)</p>		<p>AÇO INOX ASTM F899 e ASTM B488</p>
SPL4-35-33CGH	<p>Pinça de colher Cabo C com ASTM B488 ( Colher tipo Blakesley, ação única)</p> <p>3,5 x 330 (mm)</p>		<p>AÇO INOX ASTM F899 e ASTM B488</p>
SPL4-25-33DGH	<p>Pinça de colher Cabo D com ASTM B488 ( Colher tipo Blakesley, ação única)</p> <p>2,5 x 330 (mm)</p>		<p>AÇO INOX ASTM F899 e ASTM B488</p>
SPL4-35-33DGH	<p>Pinça de colher Cabo D com ASTM B488 ( Colher tipo Blakesley, ação única)</p> <p>3,5 x 330 (mm)</p>		<p>AÇO INOX ASTM F899 e ASTM B488</p>



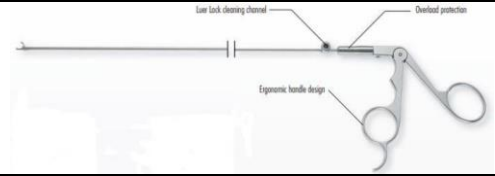

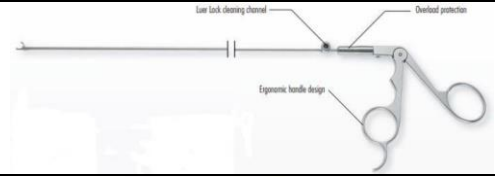

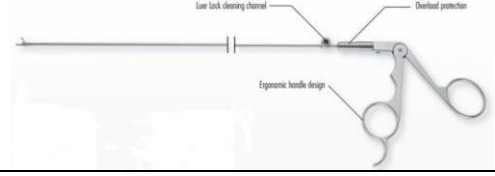
			
--	--	---	--



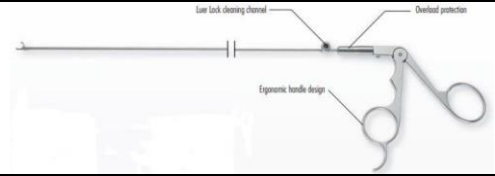

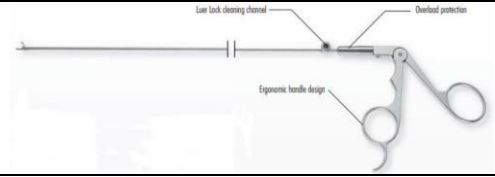

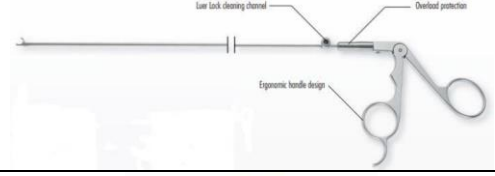
**Pinça de colher (Peça completa, cabo e haste juntos)**



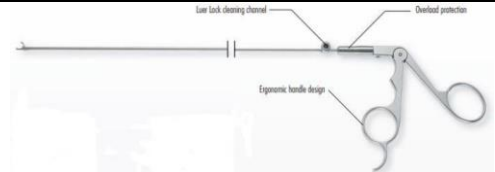

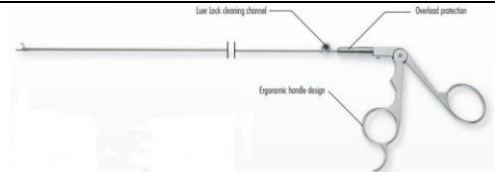

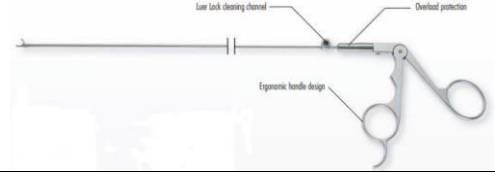
SPL5-25-29A	<p>Pinça de Colher Cabo A (Colher de mandíbula redonda, 50° na haste curva, haste 3,0 – 2,5 distalmente retificada, ação única) 2,5 x 290 (mm)</p>	 	AÇO INOX ASTM F899
SPL5-30-29A	<p>Pinça de Colher Cabo A (Colher de mandíbula redonda, 50° na haste curva, haste 3,0 – 2,5 distalmente retificada, ação única) 3,0 x 290 (mm)</p>	 	AÇO INOX ASTM F899
SPL5-35-29A	<p>Pinça de Colher Cabo A (Colher de mandíbula redonda, 50° na haste curva, haste 3,0 – 2,5 distalmente retificada, ação única)</p>		AÇO INOX ASTM F899



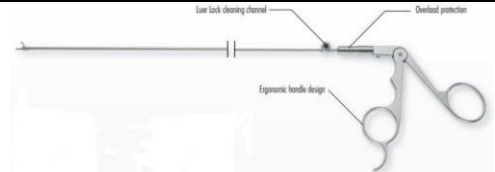

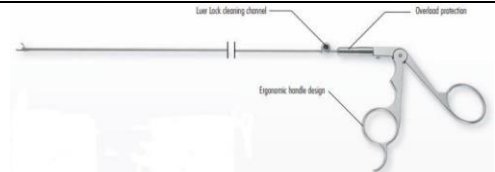
	3,5 x 290 (mm)		
SPL5-25-29B	<p>Pinça de Colher Cabo B (Colher de mandíbula redonda, 50° na haste curva, haste 3,0 – 2,5 distalmente retificada, ação única) 2,5 x 290 (mm)</p>	 	AÇO INOX ASTM F899
SPL5-30-29B	<p>Pinça de Colher Cabo B (Colher de mandíbula redonda, 50° na haste curva, haste 3,0 – 2,5 distalmente retificada, ação única) 3,0 x 290 (mm)</p>	 	AÇO INOX ASTM F899
SPL5-35-29B	<p>Pinça de Colher Cabo B (Colher de mandíbula redonda, 50° na haste curva, haste 3,0 – 2,5 distalmente retificada, ação única)</p>		AÇO INOX ASTM F899

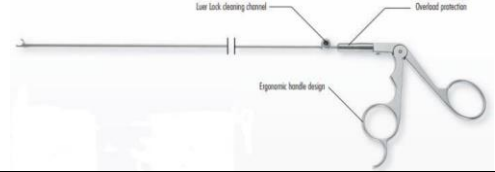
	3,5 x 290 (mm)		
SPL5-25-29C	<p>Pinça de Colher Cabo C (Colher de mandíbula redonda, 50° na haste curva, haste 3,0 – 2,5 distalmente retificada, ação única) 2,5 x 290 (mm)</p>	 	AÇO INOX ASTM F899
SPL5-30-29C	<p>Pinça de Colher Cabo C (Colher de mandíbula redonda, 50° na haste curva, haste 3,0 – 2,5 distalmente retificada, ação única) 3,0 x 290 (mm)</p>	 	AÇO INOX ASTM F899
SPL5-35-29C	<p>Pinça de Colher Cabo C (Colher de mandíbula redonda, 50° na haste curva, haste 3,0 – 2,5 distalmente retificada, ação única)</p>		AÇO INOX ASTM F899



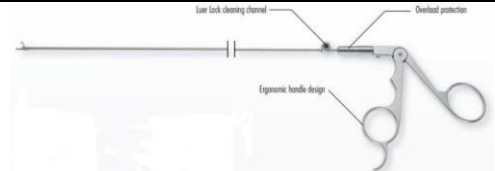

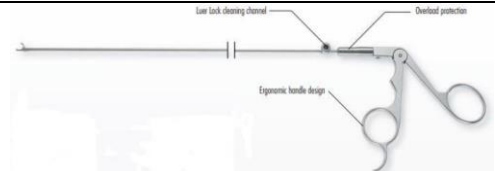

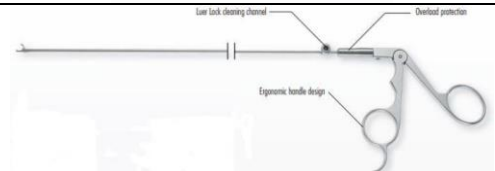
	3,5 x 290 (mm)		
SPL5-25-29D	<p>Pinça de Colher Cabo D (Colher de mandíbula redonda, 50° na haste curva, haste 3,0 – 2,5 distalmente retificada, ação única) 2,5 x 290 (mm)</p>	 	AÇO INOX ASTM F899
SPL5-30-29D	<p>Pinça de Colher Cabo D (Colher de mandíbula redonda, 50° na haste curva, haste 3,0 – 2,5 distalmente retificada, ação única) 3,0 x 290 (mm)</p>	 	AÇO INOX ASTM F899
SPL5-35-29D	<p>Pinça de Colher Cabo D (Colher de mandíbula redonda, 50° na haste curva, haste 3,0 – 2,5 distalmente retificada, ação única)</p>		AÇO INOX ASTM F899





	3,5 x 290 (mm)		
SPL5A-25-32A	<p>Pinça de Colher Cabo A ( Colher de mandíbula oval longa, 50° na haste curva, haste 3,0 – 2,5 distalmente retificada, ação única) 2,5 x 320 (mm)</p>	 	AÇO INOX ASTM F899
SPL5A-35-32A	<p>Pinça de Colher Cabo A ( Colher de mandíbula oval longa, 50° na haste curva, haste 3,0 – 2,5 distalmente retificada, ação única) 3,5 x 320 (mm)</p>	 	AÇO INOX ASTM F899
SPL5-25-32B	<p>Pinça de Colher Cabo B ( Colher de mandíbula oval longa, 50° na haste curva, haste 3,0 – 2,5 distalmente retificada, ação única)</p>		AÇO INOX ASTM F899







	2,5 x 320 (mm)		
SPL5-35-32B	<p>Pinça de Colher Cabo B ( Colher de mandíbula oval longa, 50° na haste curva, haste 3,0 – 2,5 distalmente retificada, ação única) 3,5 x 320 (mm)</p>		AÇO INOX ASTM F899
			
SPL5-25-32C	<p>Pinça de Colher Cabo C ( Colher de mandíbula oval longa, 50° na haste curva, haste 3,0 – 2,5 distalmente retificada, ação única) 2,5 x 320 (mm)</p>		AÇO INOX ASTM F899
			
SPL5-35-32C	<p>Pinça de Colher Cabo C ( Colher de mandíbula oval longa, 50° na haste curva, haste 3,0 – 2,5 distalmente retificada, ação única)</p>		AÇO INOX ASTM F899



	3,5 x 320 (mm)		
SPL5-25-32D	<p>Pinça de Colher Cabo D ( Colher de mandíbula oval longa, 50° na haste curva, haste 3,0 – 2,5 distalmente retificada, ação única) 2,5 x 320 (mm)</p>		AÇO INOX ASTM F899
			
SPL5-35-32D	<p>Pinça de Colher Cabo D ( Colher de mandíbula oval longa, 50° na haste curva, haste 3,0 – 2,5 distalmente retificada, ação única) 3,5 x 320 (mm)</p>		AÇO INOX ASTM F899
			



**Pinça de colher (Cabo e haste completos com cabo galvanizado a ouro)**

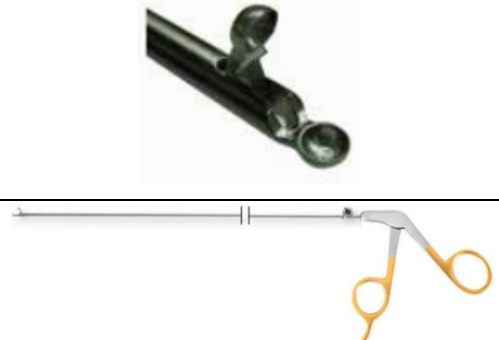
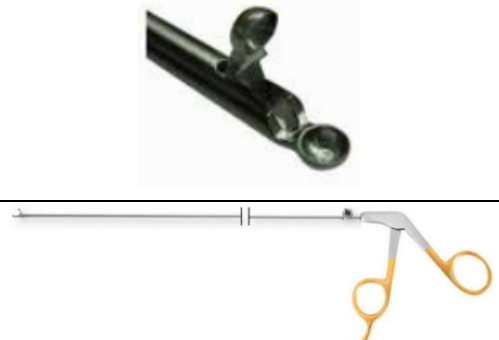

SPL5-25-29AGH	<p>Pinça de Colher Cabo A com ASTM B488 (Colher com Mandíbula Redonda, 50° na Haste Curva, Haste 3,0 – 2,5° de Afição Distal, Ação Simples)</p> <p>2,5 x 290 (mm)</p>	 	<p>AÇO INOX ASTM F899 E ASTM B488</p>
SPL5-30-29AGH	<p>Pinça de Colher Cabo A com ASTM B488 (Colher com Mandíbula Redonda, 50° na Haste Curva, Haste 3,0 – 2,5° de Afição Distal, Ação Simples)</p> <p>3,0 x 290 (mm)</p>	 	<p>AÇO INOX ASTM F899 E ASTM B488</p>
SPL5-35-29AGH	<p>Pinça de Colher Cabo A com ASTM B488 (Colher com Mandíbula Redonda, 50° na Haste Curva, Haste 3,0 – 2,5° de Afição Distal, Ação Simples)</p> <p>3,5 x 290 (mm)</p>	 	<p>AÇO INOX ASTM F899 E ASTM B488</p>

<p>SPL5-25-29BGH</p>	<p>Pinça de Colher Cabo B com ASTM B488 (Colher com Mandíbula Redonda, 50° na Haste Curva, Haste 3,0 – 2,5° de Afição Distal, Ação Simples)</p> <p>3,5 x 290 (mm)</p>	 	<p>AÇO INOX ASTM F899 E ASTM B488</p>
<p>SPL5-30-29BGH</p>	<p>Pinça de Colher Cabo B com ASTM B488 (Colher com Mandíbula Redonda, 50° na Haste Curva, Haste 3,0 – 2,5° de Afição Distal, Ação Simples)</p> <p>3,0 x 290 (mm)</p>	 	<p>AÇO INOX ASTM F899 E ASTM B488</p>
<p>SPL5-35-29BGH</p>	<p>Pinça de Colher Cabo B com ASTM B488 (Colher com Mandíbula Redonda, 50° na Haste Curva, Haste 3,0 – 2,5° de Afição Distal, Ação Simples)</p> <p>3,5 x 290 (mm)</p>	 	<p>AÇO INOX ASTM F899 E ASTM B488</p>
<p>SPL5-25-29CGH</p>	<p>Pinça de Colher Cabo C com ASTM B488 (Colher com Mandíbula Redonda, 50° na Haste Curva, Haste 3,0 – 2,5° de Afição Distal, Ação Simples)</p>		<p>AÇO INOX ASTM F899 E ASTM B488</p>

	2,5 x 290 (mm)		
SPL5-30-29CGH	Pinça de Colher Cabo C com ASTM B488 (Colher com Mandíbula Redonda, 50° na Haste Curva, Haste 3,0 – 2,5° de Afição Distal, Ação Simples)		AÇO INOX ASTM F899 E ASTM B488
	3,0 x 290 (mm)		
SPL5-35-29CGH	Pinça de Colher Cabo C com ASTM B488 (Colher com Mandíbula Redonda, 50° na Haste Curva, Haste 3,0 – 2,5° de Afição Distal, Ação Simples)		AÇO INOX ASTM F899 E ASTM B488
	3,5 x 290 (mm)		
SPL5-25-29DGH	Pinça de Colher Cabo D com ASTM B488 (Colher com Mandíbula Redonda, 50° na Haste Curva, Haste 3,0 – 2,5° de Afição Distal, Ação Simples)		AÇO INOX ASTM F899 E ASTM B488
	2,5 x 290 (mm)		



<p>SPL5-30-29DGH</p>	<p>Pinça de Colher Cabo D com ASTM B488 (Colher com Mandíbula Redonda, 50° na Haste Curva, Haste 3,0 – 2,5° de Afição Distal, Ação Simples)</p> <p>3,0 x 290 (mm)</p>		<p>AÇO INOX ASTM F899 E ASTM B488</p>
<p>SPL5-35-29DGH</p>	<p>Pinça de Colher Cabo D com ASTM B488 (Colher com Mandíbula Redonda, 50° na Haste Curva, Haste 3,0 – 2,5° de Afição Distal, Ação Simples)</p> <p>3,5 x 290 (mm)</p>		<p>AÇO INOX ASTM F899 E ASTM B488</p>
<p>SPL5A-25-32AGH</p>	<p>Pinça de Colher Cabo A com ASTM B488 (Colher com mordente oval longo, haste curvada de 50°, haste retificada distalmente de 3,0 a 2,5°, ação única)</p> <p>2,5 x 320 (mm)</p>		<p>AÇO INOX ASTM F899 E ASTM B488</p>





SPL5A-35-32AGH	<p>Pinça de Colher Cabo A com ASTM B488 (Colher com mordente oval longo, haste curvada de 50°, haste retificada distalmente de 3,0 a 2,5°, ação única)</p> <p>3,5 x 320 (mm)</p>		<p>AÇO INOX ASTM F899 E ASTM B488</p>
SPL5-25-32BGH	<p>Pinça de Colher Cabo B com ASTM B488 (Colher com mordente oval longo, haste curvada de 50°, haste retificada distalmente de 3,0 a 2,5°, ação única)</p> <p>2,5 x 320 (mm)</p>		<p>AÇO INOX ASTM F899 E ASTM B488</p>
SPL5-35-32BGH	<p>Pinça de Colher Cabo B com ASTM B488 (Colher com mordente oval longo, haste curvada de 50°, haste retificada distalmente de 3,0 a 2,5°, ação única)</p> <p>3,5 x 320 (mm)</p>		<p>AÇO INOX ASTM F899 E ASTM B488</p>

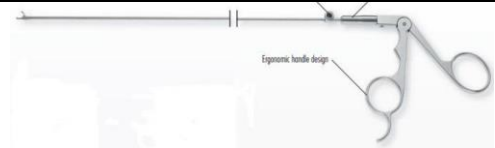

SPL5-25-32CGH	<p>Pinça de Colher Cabo C com ASTM B488 (Colher com mordente oval longo, haste curvada de 50°, haste retificada distalmente de 3,0 a 2,5°, ação única)</p> <p>2,5 x 320 (mm)</p>		<p>AÇO INOX ASTM F899 E ASTM B488</p>
SPL5-35-32CGH	<p>Pinça de Colher Cabo C com ASTM B488 (Colher com mordente oval longo, haste curvada de 50°, haste retificada distalmente de 3,0 a 2,5°, ação única)</p> <p>3,5 x 320 (mm)</p>		<p>AÇO INOX ASTM F899 E ASTM B488</p>
SPL5-25-32DGH	<p>Pinça de Colher Cabo D com ASTM B488 (Colher com mordente oval longo, haste curvada de 50°, haste retificada distalmente de 3,0 a 2,5°, ação única)</p> <p>2,5 x 320 (mm)</p>		<p>AÇO INOX ASTM F899 E ASTM B488</p>

SPL5-35-32DGH	<p>Pinça de Colher Cabo D com ASTM B488 (Colher com mordente oval longo, haste curvada de 50°, haste retificada distalmente de 3,0 a 2,5°, ação única)</p> <p>3,5 x 320 (mm)</p>		<p>AÇO INOX ASTM F899 E ASTM B488</p>
			

**Pinça de prensão (Cabo e haste completos)**

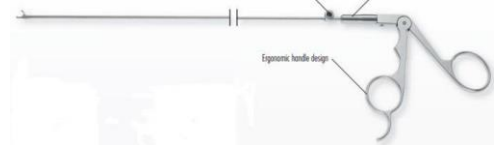
SPF1-27-35A	<p>Pinça de Colher Cabo A (Pinça tipo jacaré, ação simples) 2,7 x 350 (mm)</p>		<p>AÇO INOX ASTM F899</p>
			
SPF1-35-35A	<p>Pinça de Colher Cabo A (Pinça tipo jacaré, ação simples) 2,7 x 350 (mm)</p>		<p>AÇO INOX ASTM F899</p>

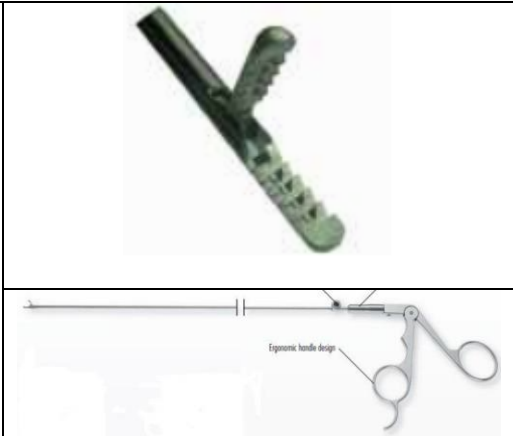
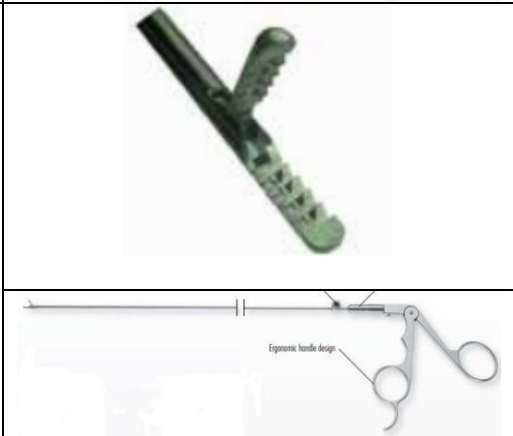



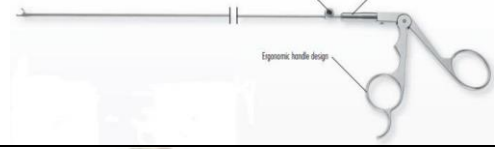

			
SPF1-27-35B	<p>Pinça de Colher Cabo B (Pinça tipo jacaré, ação simples) 2,7 x 350 (mm)</p>		AÇO INOX ASTM F899
			
SPF1-35-35B	<p>Pinça de Colher Cabo B (Pinça tipo jacaré, ação simples) 2,7 x 350 (mm)</p>		AÇO INOX ASTM F899
			



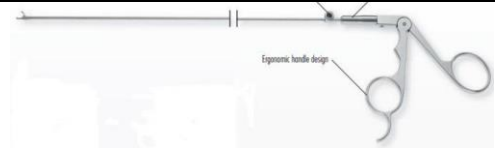

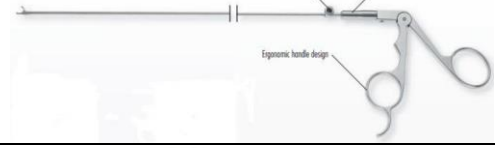

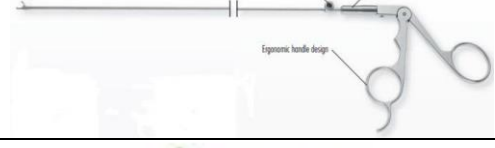
<p>SPF1-27-35C</p>	<p>Pinça de Colher Cabo C (Pinça tipo jacaré, ação simples) 2,7 x 350 (mm)</p>		<p>AÇO INOX ASTM F899</p>
<p>SPF1-35-35C</p>	<p>Pinça de Colher Cabo C (Pinça tipo jacaré, ação simples) 2,7 x 350 (mm)</p>		<p>AÇO INOX ASTM F899</p>
<p>SPF1-27-35D</p>	<p>Pinça de Colher Cabo D (Pinça tipo jacaré, ação simples) 2,7 x 350 (mm)</p>		<p>AÇO INOX ASTM F899</p>



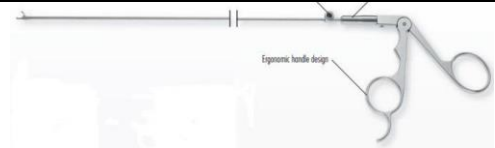

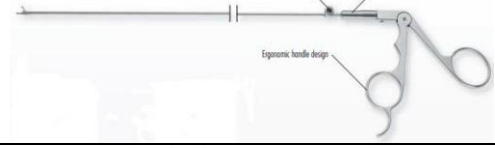
			
SPF1-35-35D	<p>Pinça de Colher Cabo D (Pinça tipo jacaré, ação simples) 2,7 x 350 (mm)</p>		AÇO INOX ASTM F899
			
SPF2-27-35A	<p>Pinça de Colher Cabo A (Pinça tipo jacaré com dente de rato, ação simples) 2,7 x 350 (mm)</p>		AÇO INOX ASTM F899
			
SPF2-35-35A	<p>Pinça de Colher Cabo A (Pinça tipo jacaré com dente de rato, ação simples) 3,5 x 350 (mm)</p>		AÇO INOX ASTM F899

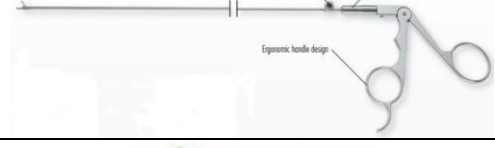
			
SPF2-27-35B	Pinça de Colher Cabo B (Pinça tipo jacaré com dente de rato, ação simples) 2,7 x 350 (mm)	 	AÇO INOX ASTM F899
SPF2-35-35B	Pinça de Colher Cabo B (Pinça tipo jacaré com dente de rato, ação simples) 3,5 x 350 (mm)	 	AÇO INOX ASTM F899
SPF2-27-35C	Pinça de Colher Cabo C (Pinça tipo jacaré com dente de rato, ação simples) 2,7 x 350 (mm)		AÇO INOX ASTM F899

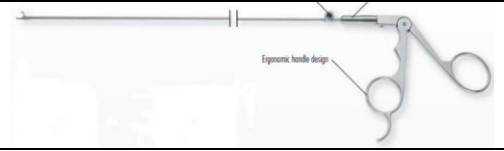

			
SPF2-35-35C	<p>Pinça de Colher Cabo C (Pinça tipo jacaré com dente de rato, ação simples) 3,5 x 350 (mm)</p>		AÇO INOX ASTM F899
			
SPF2-27-35D	<p>Pinça de Colher Cabo D (Pinça tipo jacaré com dente de rato, ação simples) 2,7 x 350 (mm)</p>		AÇO INOX ASTM F899
			
SPF2-35-35D	<p>Pinça de Colher Cabo D (Pinça tipo jacaré com dente de rato, ação simples) 3,5 x 350 (mm)</p>		AÇO INOX ASTM F899

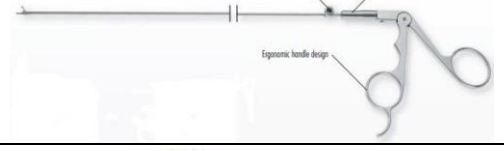

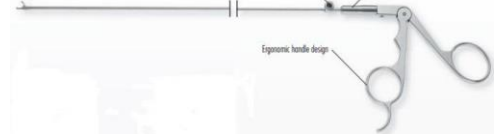

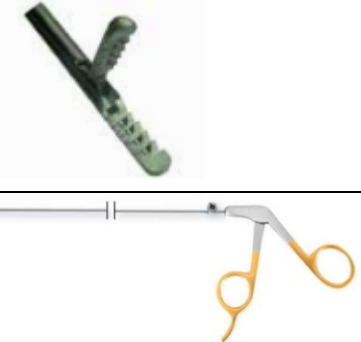
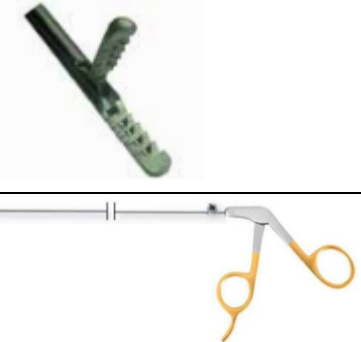
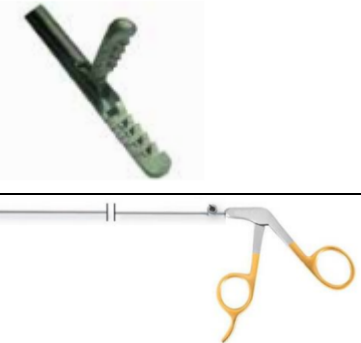

			
SPF3-25-25A	<p>Pinça de Colher Cabo A ( Colher oval de ação única com dentes de jacaré) 2,5 x 250 (mm)</p>		AÇO INOX ASTM F899
			
SPF3-30-35A	<p>Pinça de Colher Cabo A ( Colher oval de ação única com dentes de jacaré) 3,0 x 350 (mm)</p>		AÇO INOX ASTM F899
			
SPF3-25-25B	<p>Pinça de Colher Cabo B ( Colher oval de ação única com dentes de jacaré) 2,5 x 250 (mm)</p>		AÇO INOX ASTM F899



			
SPF3-30-35B	<p>Pinça de Colher Cabo B ( Colher oval de ação única com dentes de jacaré) 3,0 x 350 (mm)</p>		AÇO INOX ASTM F899
			
SPF3-25-25C	<p>Pinça de Colher Cabo C ( Colher oval de ação única com dentes de jacaré) 2,5 x 250 (mm)</p>		AÇO INOX ASTM F899
			
SPF3-30-35C	<p>Pinça de Colher Cabo C ( Colher oval de ação única com dentes de jacaré) 3,0 x 350 (mm)</p>		AÇO INOX ASTM F899





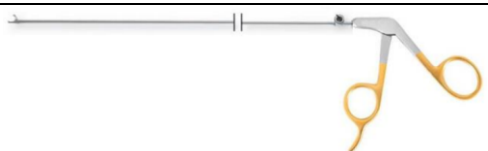

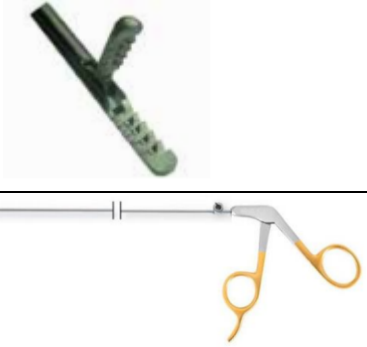
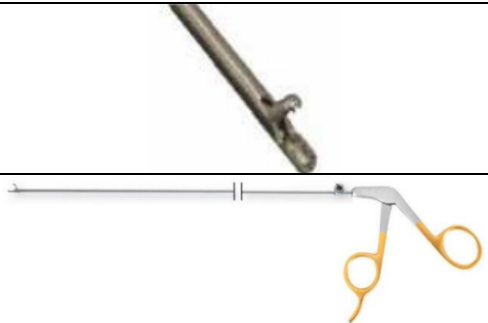
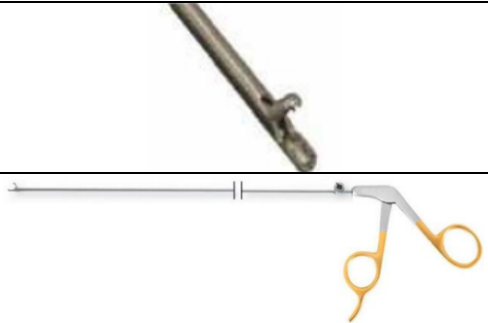
			
SPF3-25-25D	Pinça de Colher Cabo D ( Colher oval de ação única com dentes de jacaré) 2,5 x 250 (mm)	 	AÇO INOX ASTM F899
SPF3-30-35D	Pinça de Colher Cabo D ( Colher oval de ação única com dentes de jacaré) 3,0 x 350 (mm)	 	AÇO INOX ASTM F899



**Pinça de prensão (Cabo e haste completos com cabo galvanizado a ouro)**





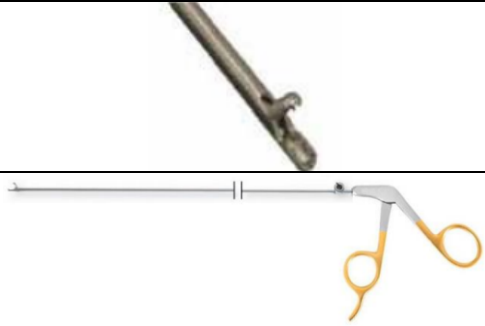
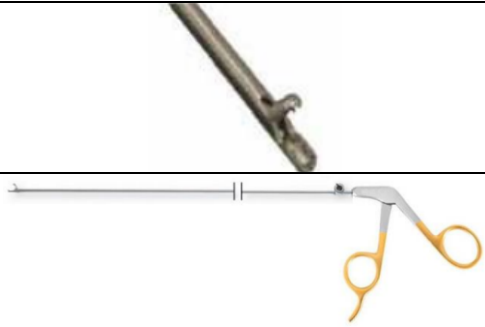
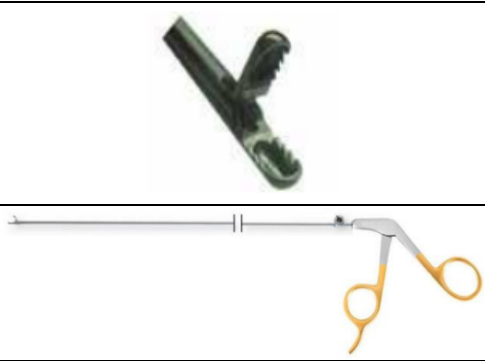

<p>SPF1-27-35AGH</p>	<p>Pinça de Colher Cabo A com ASTM B488 ( Pinça tipo Jacaré, ação única)</p> <p>2,7 x 350 (mm)</p>		<p>AÇO INOX ASTM F899 E ASTM B488</p>
<p>SPF1-35-35AGH</p>	<p>Pinça de Colher Cabo A com ASTM B488 ( Pinça tipo Jacaré, ação única)</p> <p>3,5 x 350 (mm)</p>		<p>AÇO INOX ASTM F899 E ASTM B488</p>
<p>SPF1-27-35BGH</p>	<p>Pinça de Colher Cabo B com ASTM B488 ( Pinça tipo Jacaré, ação única)</p> <p>2,7 x 350 (mm)</p>		<p>AÇO INOX ASTM F899 E ASTM B488</p>
<p>SPF1-35-35BGH</p>	<p>Pinça de Colher Cabo B com ASTM B488 ( Pinça tipo Jacaré, ação única)</p> <p>3,5 x 350 (mm)</p>		<p>AÇO INOX ASTM F899 E ASTM B488</p>





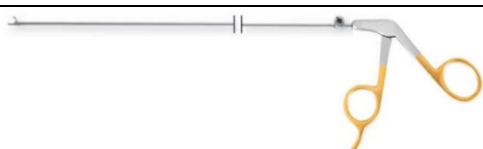

			
SPF1-27-35CGH	<p>Pinça de Colher Cabo C com ASTM B488 ( Pinça tipo Jacaré, ação única)</p> <p>2,7 x 350 (mm)</p>		<p>AÇO INOX ASTM F899 E ASTM B488</p>
			
SPF1-35-35CGH	<p>Pinça de Colher Cabo C com ASTM B488 ( Pinça tipo Jacaré, ação única)</p> <p>3,5 x 350 (mm)</p>		<p>AÇO INOX ASTM F899 E ASTM B488</p>
			
SPF1-27-35D	<p>Pinça de Colher Cabo D com ASTM B488 ( Pinça tipo Jacaré, ação única)</p> <p>2,7 x 350 (mm)</p>		<p>AÇO INOX ASTM F899 E ASTM B488</p>
			

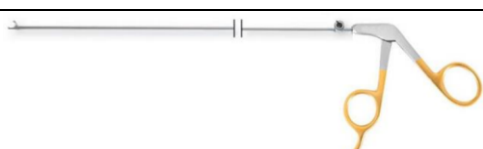
SPF1-35-35D	<p>Pinça de Colher Cabo D com ASTM B488 ( Pinça tipo Jacaré, ação única)</p> <p>3,5 x 350 (mm)</p>		<p>AÇO INOX ASTM F899 E ASTM B488</p>
SPF2-27-35AGH	<p>Pinça de Colher Cabo A com ASTM B488 ( Pinça tipo Jacaré com dente de rato, ação única)</p> <p>2,7 x 350 (mm)</p>		<p>AÇO INOX ASTM F899 E ASTM B488</p>
SPF2-35-35AGH	<p>Pinça de Colher Cabo A com ASTM B488 ( Pinça tipo Jacaré com dente de rato, ação única)</p> <p>3,5 x 350 (mm)</p>		<p>AÇO INOX ASTM F899 E ASTM B488</p>
SPF2-27-35BGH	<p>Pinça de Colher Cabo B com ASTM B488 ( Pinça tipo Jacaré com dente de rato, ação única)</p>		<p>AÇO INOX ASTM F899 E ASTM B488</p>





	2,7 x 350 (mm)		
SPF2-35-35BGH	Pinça de Colher Cabo B com ASTM B488 ( Pinça tipo Jacaré com dente de rato, ação única)		AÇO INOX ASTM F899 E ASTM B488
	3,5 x 350 (mm)		
SPF2-27-35CGH	Pinça de Colher Cabo C com ASTM B488 ( Pinça tipo Jacaré com dente de rato, ação única)		AÇO INOX ASTM F899 E ASTM B488
	2,7 x 350 (mm)		
SPF2-35-35CGH	Pinça de Colher Cabo C com ASTM B488 ( Pinça tipo Jacaré com dente de rato, ação única)		AÇO INOX ASTM F899 E ASTM B488
	3,5 x 350 (mm)		





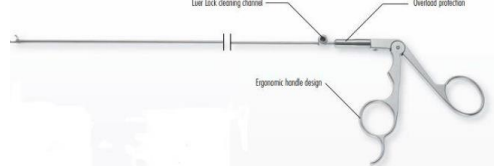

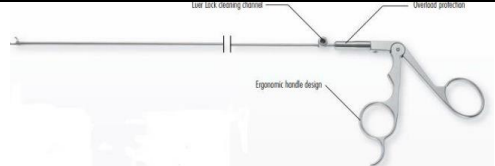
SPF2-27-35DGH	<p>Pinça de Colher Cabo D com ASTM B488 ( Pinça tipo Jacaré com dente de rato, ação única)</p> <p>2,7 x 350 (mm)</p>		<p>AÇO INOX ASTM F899 E ASTM B488</p>
SPF2-35-35DGH	<p>Pinça de Colher Cabo D com ASTM B488 ( Pinça tipo Jacaré com dente de rato, ação única)</p> <p>3,5 x 350 (mm)</p>		<p>AÇO INOX ASTM F899 E ASTM B488</p>
SPF3-25-25AGH	<p>Pinça de Colher Cabo A com ASTM B488 ( Ação única, colher oval com dentes de jacaré)</p> <p>2,5 x 250 (mm)</p>		<p>AÇO INOX ASTM F899 E ASTM B488</p>
SPF3-30-35AGH	<p>Pinça de Colher Cabo A com ASTM B488 ( Ação única, colher oval com dentes de jacaré)</p>		<p>AÇO INOX ASTM F899 E ASTM B488</p>



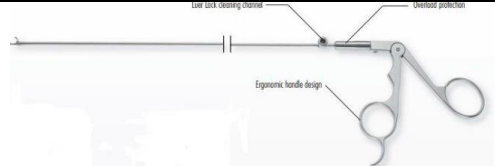

	3,0 x 350 (mm)		
SPF3-25-25BGH	Pinça de Colher Cabo B com ASTM B488 ( Aço única, colher oval com dentes de jacaré)		AÇO INOX ASTM F899 E ASTM B488
	2,5 x 250 (mm)		
SPF3-30-35BGH	Pinça de Colher Cabo B com ASTM B488 ( Aço única, colher oval com dentes de jacaré)		AÇO INOX ASTM F899 E ASTM B488
	3,0 x 350 (mm)		
SPF3-25-25CGH	Pinça de Colher Cabo C com ASTM B488 ( Aço única, colher oval com dentes de jacaré)		AÇO INOX ASTM F899 E ASTM B488
	2,5 x 250 (mm)		

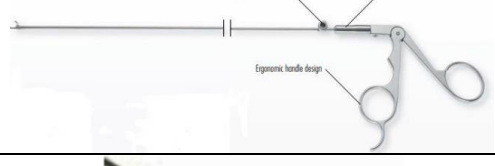
SPF3-30-35CGH	<p>Pinça de Colher Cabo C com ASTM B488 ( Aço única, colher oval com dentes de jacaré)</p> <p>3,0 x 350 (mm)</p>	 	<p>AÇO INOX ASTM F899 E ASTM B488</p>
SPF3-25-25DGH	<p>Pinça de Colher Cabo A com ASTM B488 ( Aço única, colher oval com dentes de jacaré)</p> <p>2,5 x 250 (mm)</p>	 	<p>AÇO INOX ASTM F899 E ASTM B488</p>
SPF3-30-35DGH	<p>Pinça de Colher Cabo D com ASTM B488 ( Aço única, colher oval com dentes de jacaré)</p> <p>3,0 x 350 (mm)</p>	 	<p>AÇO INOX ASTM F899 E ASTM B488</p>



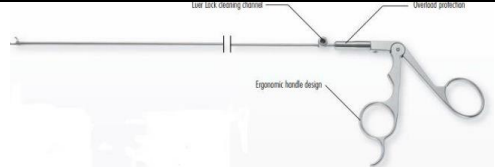

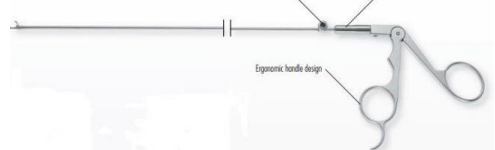

**Tesoura (Cabo e haste)**







<p>SPS1-27-35A</p>	<p>Tesoura Cabo A ( Tesoura de Gancho, ação simples) 2,7 x 350 (mm)</p>	 	<p>AÇO INOX ASTM F899</p>
<p>SPS1-35-35A</p>	<p>Tesoura Cabo A ( Tesoura de Gancho, ação simples) 3,5 x 350 (mm)</p>	 	<p>AÇO INOX ASTM F899</p>
<p>SPS1-27-35B</p>	<p>Tesoura Cabo B ( Tesoura de Gancho, ação simples) 2,7 x 350 (mm)</p>		<p>AÇO INOX ASTM F899</p>



			
SPS1-35-35B	<p>Tesoura Cabo B ( Tesoura de Gancho, ação simples) 3,5 x 350 (mm)</p>	 	<p>AÇO INOX ASTM F899</p>
SPS1-27-35C	<p>Tesoura Cabo C ( Tesoura de Gancho, ação simples) 2,7 x 350 (mm)</p>	 	<p>AÇO INOX ASTM F899</p>
SPS1-35-35C	<p>Tesoura Cabo C ( Tesoura de Gancho, ação simples) 3,5 x 350 (mm)</p>		<p>AÇO INOX ASTM F899</p>

			
SPS1-27-35D	<p>Tesoura Cabo D ( Tesoura de Gancho, ação simples) 2,7 x 350 (mm)</p>	 	<p>AÇO INOX ASTM F899</p>
SPS1-35-35D	<p>Tesoura Cabo D ( Tesoura de Gancho, ação simples) 3,5 x 350 (mm)</p>	 	<p>AÇO INOX ASTM F899</p>

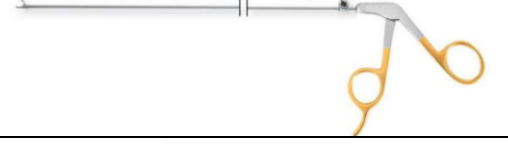

**Tesoura (Cabo e haste completos juntos com cabo galvanizado a ouro)**

SPS1-27-35A	<p>Tesoura Cabo A com ASTM B488 ( Tesoura de Gancho, ação simples) 2,7 x 350 (mm)</p>	 	<p>AÇO INOX ASTM F899 E ASTM B488</p>
SPS1-35-35A	<p>Tesoura Cabo A com ASTM B488 ( Tesoura de Gancho, ação simples) 3,5 x 350 (mm)</p>	 	<p>AÇO INOX ASTM F899 E ASTM B488</p>
SPS1-27-35B	<p>Tesoura Cabo B com ASTM B488 ( Tesoura de Gancho, ação simples) 2,7 x 350 (mm)</p>	 	<p>AÇO INOX ASTM F899 E ASTM B488</p>
SPS1-35-35B	<p>Tesoura Cabo B com ASTM B488 ( Tesoura de Gancho, ação simples) 3,5 x 350 (mm)</p>		<p>AÇO INOX ASTM F899 E ASTM B488</p>



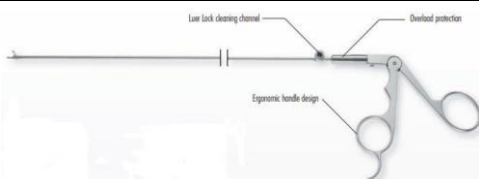

			
SPS1-27-35C	Tesoura Cabo C com ASTM B488 ( Tesoura de Gancho, ação simples) 2,7 x 350 (mm)		AÇO INOX ASTM F899 E ASTM B488
			
SPS1-35-35C	Tesoura Cabo C com ASTM B488 ( Tesoura de Gancho, ação simples) 3,5 x 350 (mm)		AÇO INOX ASTM F899 E ASTM B488
			
SPS1-27-35D	Tesoura Cabo D com ASTM B488 ( Tesoura de Gancho, ação simples) 2,7 x 350 (mm)		AÇO INOX ASTM F899 E ASTM B488
			

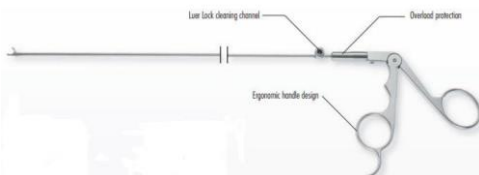

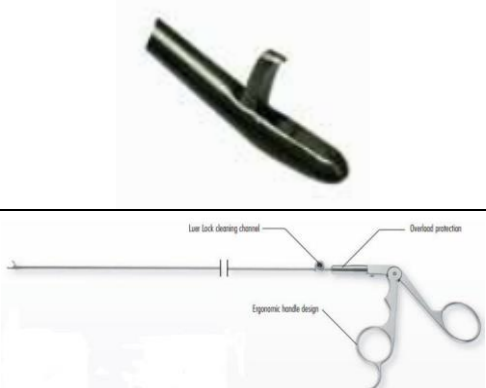
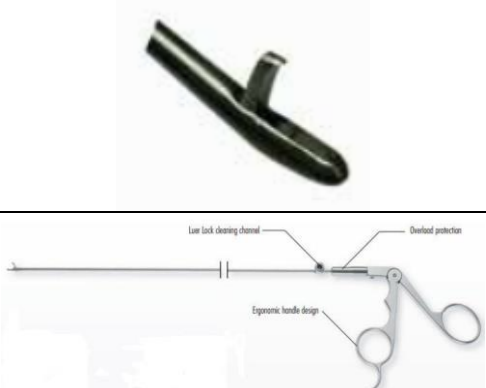
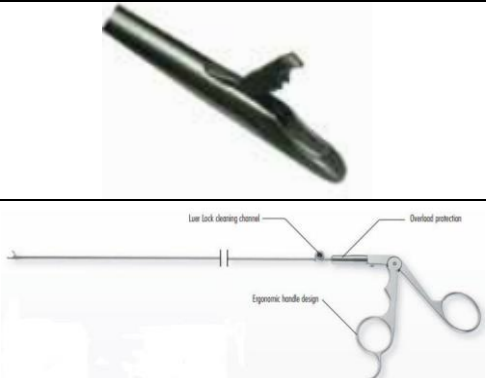

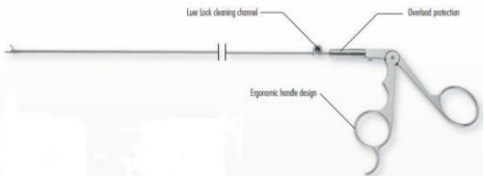
SPS1-35-35D	Tesoura Cabo D com ASTM B488 ( Tesoura de Gancho, ação simples) 3,5 x 350 (mm)		AÇO INOX ASTM F899 E ASTM B488
			

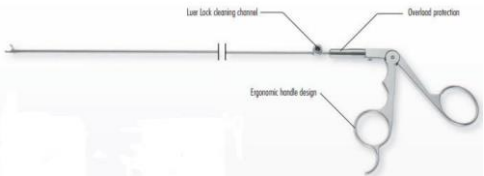

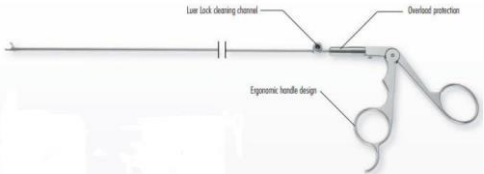

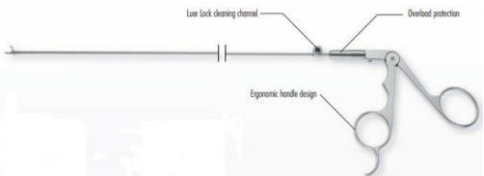
### Pinça Endo

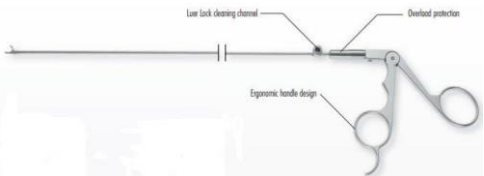

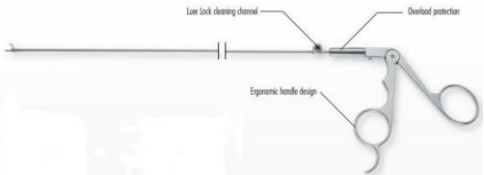

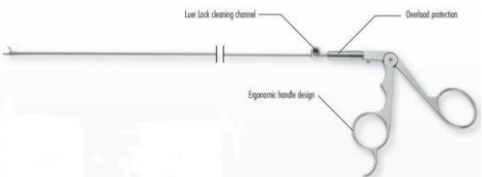
SPP1-25-33A	Forceps Cabo A ( Forceps para punção Endo-Hook sem dente, mandíbula angulada de 15° para cima, punção com 1,2 mm, ação simples) 2,5 x 330 (mm)		AÇO INOX ASTM F899
			
SPP1-25-33B	Forceps Cabo B ( Forceps para punção Endo-Hook sem dente, mandíbula angulada de 15° para cima, punção com 1,2 mm, ação simples) 2,5 x 330 (mm)		AÇO INOX ASTM F899
			

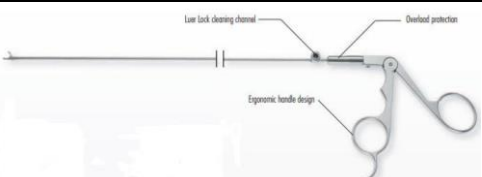

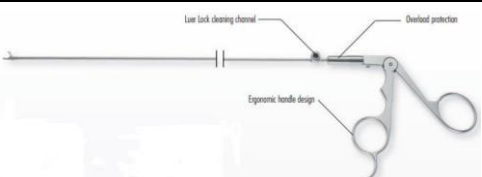

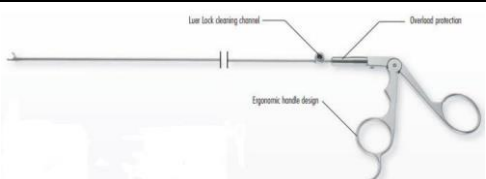
<p>SPP1-25-33C</p>	<p>Forceps Cabo C ( Forceps para punção Endo-Hook sem dente, mandíbula angulada de 15° para cima, punção com 1,2 mm, ação simples) 2,5 x 330 (mm)</p>		<p>AÇO INOX ASTM F899</p>
<p>SPP1-25-33D</p>	<p>Forceps Cabo D ( Forceps para punção Endo-Hook sem dente, mandíbula angulada de 15° para cima, punção com 1,2 mm, ação simples) 2,5 x 330 (mm)</p>		<p>AÇO INOX ASTM F899</p>
<p>SPP2-27-35A</p>	<p>Forceps Cabo A ( Forceps Endo-Hook com dente, ação simples) 2,7 x 350 (mm)</p>		<p>AÇO INOX ASTM F899</p>

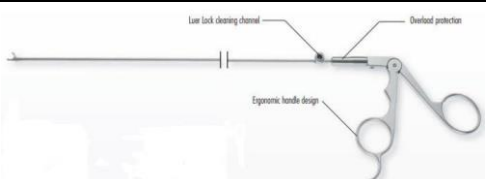

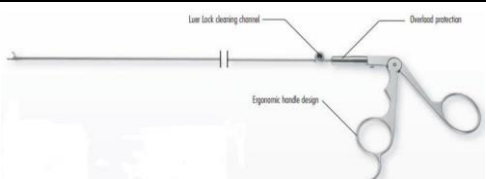

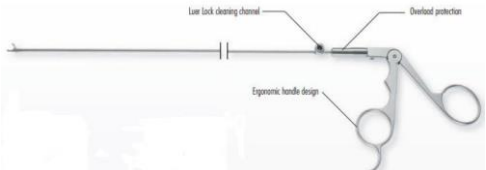
SPP2-35-25A	<p>Forceps Cabo A ( Forceps Endo-Hook com dente, ação simples) 3,5 x 250 (mm)</p>	 	AÇO INOX ASTM F899
SPP2-27-35B	<p>Forceps Cabo B ( Forceps Endo-Hook com dente, ação simples) 2,7 x 350 (mm)</p>	 	AÇO INOX ASTM F899
SPP2-35-25B	<p>Forceps Cabo B ( Forceps Endo-Hook com dente, ação simples) 3,5 x 250 (mm)</p>	 	AÇO INOX ASTM F899

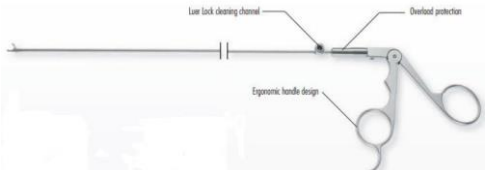
SPP2-27-35C	<p>Forceps Cabo C ( Forceps Endo-Hook com dente, ação simples) 2,7 x 350 (mm)</p>	 	AÇO INOX ASTM F899
SPP2-35-25C	<p>Forceps Cabo C ( Forceps Endo-Hook com dente, ação simples) 3,5 x 250 (mm)</p>	 	AÇO INOX ASTM F899
SPP2-27-35D	<p>Forceps Cabo D ( Forceps Endo-Hook com dente, ação simples) 2,7 x 350 (mm)</p>	 	AÇO INOX ASTM F899

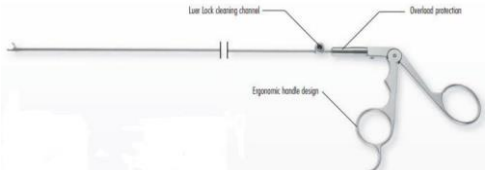
<p>SPP2-35-25D</p>	<p>Forceps Cabo D ( Forceps Endo-Hook com dente, ação simples) 3,5 x 250 (mm)</p>	 	<p>AÇO INOX ASTM F899</p>
<p>SPP3-27-35A</p>	<p>Forceps Cabo A ( Forceps Endo-Hook com dente, ação simples) 2,7 x 350 (mm)</p>	 	<p>AÇO INOX ASTM F899</p>
<p>SPP3-35-25A</p>	<p>Forceps Cabo A ( Forceps Endo-Hook com dente, ação simples) 3,5 x 250 (mm)</p>	 	<p>AÇO INOX ASTM F899</p>

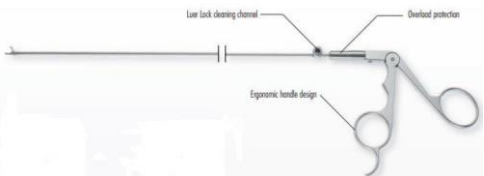

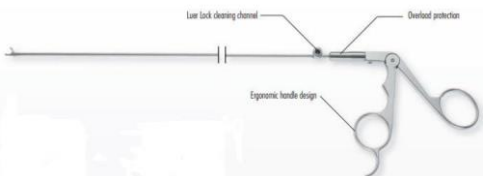
SPP3-27-35B	<p>Forceps Cabo B ( Forceps Endo-Hook com dente, ação simples) 2,7 x 350 (mm)</p>	 	AÇO INOX ASTM F899
SPP3-35-25B	<p>Forceps Cabo B ( Forceps Endo-Hook com dente, ação simples) 3,5 x 250 (mm)</p>	 	AÇO INOX ASTM F899
SPP3-27-35C	<p>Forceps Cabo C ( Forceps Endo-Hook com dente, ação simples) 2,7 x 350 (mm)</p>	 	AÇO INOX ASTM F899

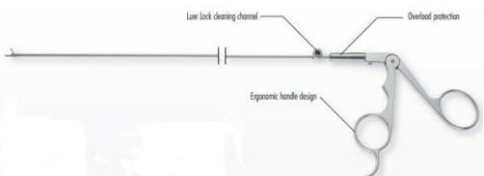

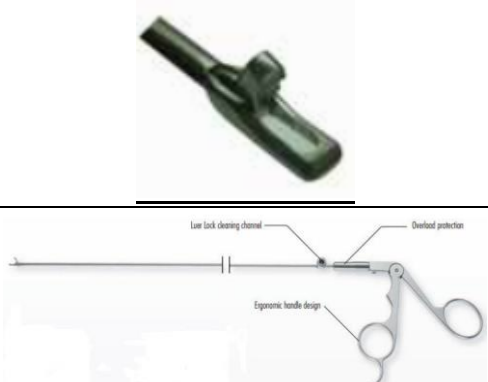



SPP3-35-25C	<p>Forceps Cabo C ( Forceps Endo-Hook com dente, ação simples) 3,5 x 250 (mm)</p>	 	AÇO INOX ASTM F899
SPP3-27-35D	<p>Forceps Cabo D ( Forceps Endo-Hook com dente, ação simples) 2,7 x 350 (mm)</p>	 	AÇO INOX ASTM F899
SPP3-35-25D	<p>Forceps Cabo D ( Forceps Endo-Hook com dente, ação simples) 3,5 x 250 (mm)</p>	 	AÇO INOX ASTM F899







<p>SPP5-50-250A</p>	<p>Forceps Cabo A ( Perfurador tipo bico de pato, pequeno, mandíbula com ângulo de 15° para cima, ação única) 5,0 x 250 (mm)</p>	 	<p>AÇO INOX ASTM F899</p>
<p>SPP5-50-250B</p>	<p>Forceps Cabo B ( Perfurador tipo bico de pato, pequeno, mandíbula com ângulo de 15° para cima, ação única) 5,0 x 250 (mm)</p>	 	<p>AÇO INOX ASTM F899</p>
<p>SPP5-50-250C</p>	<p>Forceps Cabo C ( Perfurador tipo bico de pato, pequeno, mandíbula com ângulo de 15° para cima, ação única) 5,0 x 250 (mm)</p>	 	<p>AÇO INOX ASTM F899</p>





SPP5-50-25D	<p>Forceps Cabo D ( Perfurador tipo bico de pato, pequeno, mandíbula com ângulo de 15° para cima, ação única) 5,0 x 250 (mm)</p>		AÇO INOX ASTM F899
-------------	--	---	--------------------



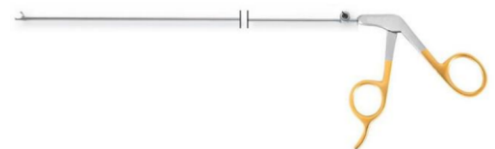



**Pinça Endo (Cabo e Haste Completos com Cabo Galvanizado a Ouro)**



SPP1-25-33AGH	<p>Forceps Cabo A com ASTM B488 ( Perfurador Endo-Hook sem dente, mandíbula angulada de 15° para cima, punção com 1,2 mm, ação simples) 2,5 x 330 (mm)</p>		AÇO INOX ASTM F899 E ASTM B488
SPP1-25-33BGH	<p>Forceps Cabo B com ASTM B488 ( Perfurador Endo-Hook sem dente, mandíbula angulada de 15° para cima, punção com 1,2 mm, ação simples) 2,5 x 330 (mm)</p>		AÇO INOX ASTM F899 E ASTM B488

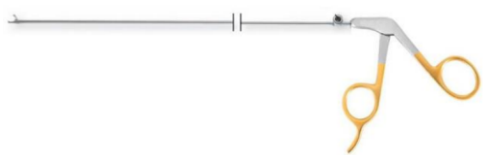

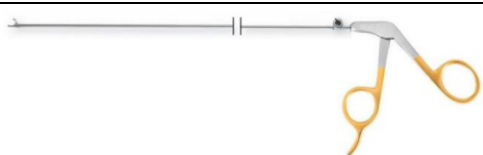

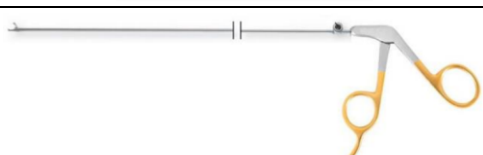
SPP1-25-33CGH	<p>Forceps Cabo C com ASTM B488 ( Perfurador Endo-Hook sem dente, mandíbula angulada de 15° para cima, punção com 1,2 mm, ação simples) 2,5 x 330 (mm)</p>	 	<p>AÇO INOX ASTM F899 E ASTM B488</p>
SPP1-25-33DGH	<p>Forceps Cabo D com ASTM B488 ( Perfurador Endo-Hook sem dente, mandíbula angulada de 15° para cima, punção com 1,2 mm, ação simples) 2,5 x 330 (mm)</p>	 	<p>AÇO INOX ASTM F899 E ASTM B488</p>
SPP2-27-35AGH	<p>Forceps Cabo A com ASTM B488 ( Punção Endo-Hook com dente, ação simples) 2,7 x 350 (mm)</p>	 	<p>AÇO INOX ASTM F899 E ASTM B488</p>
SPP2-35-25AGH	<p>Forceps Cabo A com ASTM B488 ( Punção Endo-Hook com dente, ação simples)</p>		<p>AÇO INOX ASTM F899 E ASTM B488</p>

	3,5 x 250 (mm)		
SPP2-27-35BGH	<p>Forceps Cabo B com ASTM B488 ( Punção Endo-Hook com dente, ação simples) 2,7 x 350 (mm)</p>		<p>AÇO INOX ASTM F899 E ASTM B488</p>
			
SPP2-35-25BGH	<p>Forceps Cabo B com ASTM B488 ( Punção Endo-Hook com dente, ação simples) 3,5 x 250 (mm)</p>		<p>AÇO INOX ASTM F899 E ASTM B488</p>
			
SPP2-27-35CGH	<p>Forceps Cabo C com ASTM B488 ( Punção Endo-Hook com dente, ação simples) 2,7 x 350 (mm)</p>		<p>AÇO INOX ASTM F899 E ASTM B488</p>
			

SPP2-35-25CGH	<p>Forceps Cabo C com ASTM B488 ( Punção Endo-Hook com dente, ação simples) 3,5 x 250 (mm)</p>		<p>AÇO INOX ASTM F899 E ASTM B488</p>
SPP2-27-35DGH	<p>Forceps Cabo D com ASTM B488 ( Punção Endo-Hook com dente, ação simples) 2,7 x 350 (mm)</p>		<p>AÇO INOX ASTM F899 E ASTM B488</p>
SPP2-35-25DGH	<p>Forceps Cabo D com ASTM B488 ( Punção Endo-Hook com dente, ação simples) 3,5 x 250 (mm)</p>		<p>AÇO INOX ASTM F899 E ASTM B488</p>
SPP3-27-35AGH	<p>Forceps Cabo A com ASTM B488 ( Punção Endo-Hook com dente, ação simples) 2,7 x 350 (mm)</p>		<p>AÇO INOX ASTM F899 E ASTM B488</p>



			
SPP3-35-25AGH	<p>Forceps Cabo A com ASTM B488 ( Punção Endo-Hook com dente, ação simples) 3,5 x 250 (mm)</p>	 	<p>AÇO INOX ASTM F899 E ASTM B488</p>
SPP3-27-35BGH	<p>Forceps Cabo B com ASTM B488 ( Punção Endo-Hook com dente, ação simples) 2,7 x 350 (mm)</p>	 	<p>AÇO INOX ASTM F899 E ASTM B488</p>
SPP3-35-25BGH	<p>Forceps Cabo B com ASTM B488 ( Punção Endo-Hook com dente, ação simples) 3,5 x 250 (mm)</p>	 	<p>AÇO INOX ASTM F899 E ASTM B488</p>



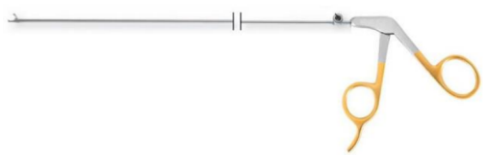

SPP3-27-35CGH	<p>Forceps Cabo C com ASTM B488 ( Punção Endo-Hook com dente, ação simples) 2,7 x 350 (mm)</p>		<p>AÇO INOX ASTM F899 E ASTM B488</p>
SPP3-35-25CGH	<p>Forceps Cabo C com ASTM B488 ( Punção Endo-Hook com dente, ação simples) 3,5 x 250 (mm)</p>		<p>AÇO INOX ASTM F899 E ASTM B488</p>
SPP3-27-35DGH	<p>Forceps Cabo D com ASTM B488 ( Punção Endo-Hook com dente, ação simples) 2,7 x 350 (mm)</p>		<p>AÇO INOX ASTM F899 E ASTM B488</p>





SPP3-35-25DGH	<p>Forceps Cabo C com ASTM B488 ( Punção Endo-Hook com dente, ação simples) 3,5 x 250 (mm)</p>		AÇO INOX ASTM F899
SPP5-50-250AGH	<p>Forceps Cabo A com ASTM B488 ( Punção bico de pato, pequena, mandíbula angulada de 15° para cima, ação simples) 5,0 x 250 (mm)</p>		AÇO INOX ASTM F899 E ASTM B488
SPP5-50-250BGH	<p>Forceps Cabo B com ASTM B488 ( Punção bico de pato, pequena, mandíbula angulada de 15° para cima, ação simples) 5,0 x 250 (mm)</p>		AÇO INOX ASTM F899 E ASTM B488
SPP5-50-250CGH	<p>Forceps Cabo C com ASTM B488 ( Punção bico de pato, pequena, mandíbula angulada de 15° para cima, ação</p>		AÇO INOX ASTM F899 E ASTM B488

	simples) 5,0 x 250 (mm)		
SPP5-50-25DGH	Forceps Cabo D com ASTM B488 ( Punção bico de pato, pequena, mandíbula angulada de 15° para cima, ação simples) 5,0 x 250 (mm)	 	AÇO INOX ASTM F899 E ASTM B488



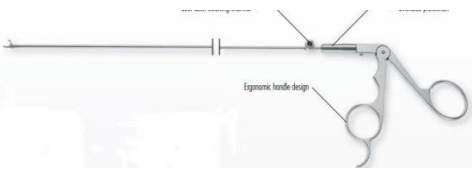

**Pincel Intradiscal**

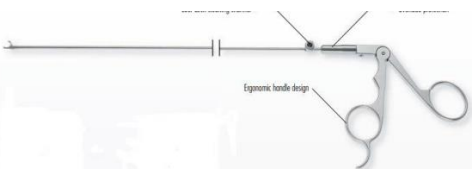
SPL-35-330	Arredondador intradiscal ( Colher do tipo Pinça de prensão)  3,5 x 330 (mm)	 	AÇO INOX ASTM F899
------------	---	---	--------------------

SPG-35-330	<p>Arredondador intradiscal ( Colher do tipo Pinça de prensão)</p> <p>3,5 x 330 (mm)</p>		AÇO INOX ASTM F899
			
SPL-50-290	<p>Arredondador intradiscal ( Colher do tipo Pinça de prensão)</p> <p>5,0 x 290 (mm)</p>		AÇO INOX ASTM F899
			
SPG-50-290	<p>Arredondador intradiscal ( Colher do tipo Pinça de prensão)</p> <p>5,0 x 290 (mm)</p>		AÇO INOX ASTM F899

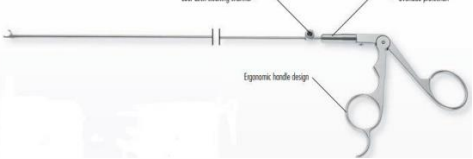
			
<p>SPFL1-25-33E</p>	<p>Instrumentos com ponta distal flexível Cabo E ( Pinça de prensão de ação única, colher com dentes de jacaré, espiral distal flexível, espiral ascendente curvada, mordedura vertical, com orifício de limpeza, abertura da mandíbula de 90°) 2,5 x 330 (mm)</p>	 	<p>AÇO INOX ASTM F899</p>
<p>SPFL1-30-33E</p>	<p>Instrumentos com ponta distal flexível Cabo E ( Pinça de prensão de ação única, colher com dentes de jacaré, espiral distal flexível, espiral ascendente curvada, mordedura vertical, com orifício de limpeza, abertura da mandíbula de 90°) 3,0 x 330 (mm)</p>	 	<p>AÇO INOX ASTM F899</p>

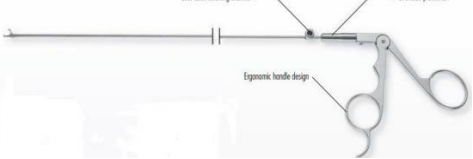
<p>SPFL4-25-33E</p>	<p>Instrumentos com ponta distal flexível Cabo E ( Pinça de prensão de dupla ação, colher com dentes de jacaré, espiral distal flexível, espiral ascendente curvada, mordedura horizontal, com orifício de limpeza, abertura da mandíbula de 90°) 2,5 x 330 (mm)</p>		<p>AÇO INOX ASTM F899</p>
<p>SPFL4-30-33E</p>	<p>Instrumentos com ponta distal flexível Cabo E ( Pinça de prensão de dupla ação, colher com dentes de jacaré, espiral distal flexível, espiral ascendente curvada, mordedura horizontal, com orifício de limpeza, abertura da mandíbula de 90°) 3,0 x 330 (mm)</p>		<p>AÇO INOX ASTM F899</p>
<p>SPFL3-25-33E</p>	<p>Instrumentos com ponta distal flexível Cabo E ( Pinça de prensão, dupla ação, colher com dentes de jacaré, espiral distal flexível, espiral curvada para cima, mordida</p>		<p>AÇO INOX ASTM F899</p>







	vertical, com porta de limpeza, abertura da mandíbula 90º 2,5 x 330 (mm)		
SPFL3-30-33E	Instrumentos com ponta distal flexível Cabo E ( Pinça de prensão, dupla ação, colher com dentes de jacaré, espiral distal flexível, espiral curvada para cima, mordida vertical, com porta de limpeza, abertura da mandíbula 90º) 3,0 x 330 (mm)	 	AÇO INOX ASTM F899
SPFL2-25-33E	Instrumentos com ponta distal flexível Cabo E ( Pinça de prensão de dupla ação, colher com dentes de jacaré, espiral distal flexível, espiral reta, mordedura horizontal, com orifício de limpeza, abertura da mandíbula 90º) 2,5 x 330 (mm)	 	AÇO INOX ASTM F899

SPFL2-30-33E	<p>Instrumentos com ponta distal flexível</p> <p>Cabo E ( Pinça de apreensão de dupla ação, colher com dentes de jacaré, espiral distal flexível, espiral reta, mordedura horizontal, com orifício de limpeza, abertura da mandíbula 90º)</p> <p>3,0 x 330 (mm)</p>		AÇO INOX ASTM F899
--------------	---	---	--------------------

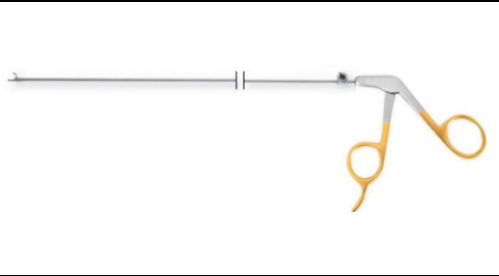
**Instrumentos com Haste Distal Flexível (Cabo e Haste Completos com Cabo Galvanizado a Ouro)**



SPFL1-25-33EGH	<p>Instrumentos com ponta distal flexível</p> <p>Cabo E com ASTM B488 ( Pinça de apreensão de ação única, colher com dentes de jacaré, espiral distal flexível, espiral ascendente curvada, mordedura vertical, com orifício de limpeza, abertura da mandíbula de 90º)</p> <p>2,5 x 330 (mm)</p>		AÇO INOX ASTM F899 E ASTM B488
SPFL1-30-33EGH	<p>Instrumentos com ponta distal flexível</p> <p>Cabo E com ASTM B488 ( Pinça de apreensão de ação única, colher com</p>		AÇO INOX ASTM F899 E ASTM B488



	dentes de jacaré, espiral distal flexível, espiral ascendente curvada, mordedura vertical, com orifício de limpeza, abertura da mandíbula de 90° 3,0 x 330 (mm)		
SPFL4-25-33EGH	Instrumentos com ponta distal flexível Cabo E com ASTM B488 ( Pinça de preensão de ação dupla, colher com dentes de jacaré, espiral distal flexível, espiral ascendente curvada, mordedura horizontal, com orifício de limpeza, abertura da mandíbula de 90° 2,5 x 330 (mm)		AÇO INOX ASTM F899 E ASTM B488
			
SPFL4-30-33EGH	Instrumentos com ponta distal flexível Cabo E com ASTM B488 ( Pinça de preensão de ação dupla, colher com dentes de jacaré, espiral distal flexível, espiral ascendente curvada, mordedura horizontal, com orifício de limpeza, abertura da mandíbula de 90° 3,0 x 330 (mm)		AÇO INOX ASTM F899 E ASTM B488
			
SPFL3-25-33EGH	Instrumentos com ponta distal flexível Cabo E com ASTM B488 ( Pinça de		AÇO INOX ASTM F899 E ASTM B488

	preensão, ação dupla, colher com dentes de jacaré, espiral distal flexível, espiral ascendente curvada, mordedura vertical, com orifício de limpeza, abertura da mandíbula de 90° 2,5 x 330 (mm)		
SPFL3-30-33EGH	Instrumentos com ponta distal flexível Cabo E com ASTM B488 (Pinça de preensão, ação dupla, colher com dentes de jacaré, espiral distal flexível, espiral ascendente curvada, mordedura vertical, com orifício de limpeza, abertura da mandíbula de 90°) 3,0 x 330 (mm)		AÇO INOX ASTM F899 E ASTM B488
			
SPFL2-25-33EGH	Instrumentos com ponta distal flexível Cabo E com ASTM B488 (Pinça de preensão de dupla ação, colher com dentes de jacaré, espiral distal flexível, espiral reta, mordedura horizontal, com orifício de limpeza, abertura da mandíbula de 90°) 2,5 x 330 (mm)		AÇO INOX ASTM F899 E ASTM B488
			
SPFL2-30-33EGH	Instrumentos com ponta distal flexível Cabo E com ASTM B488 (Pinça de		AÇO INOX ASTM F899 E ASTM B488

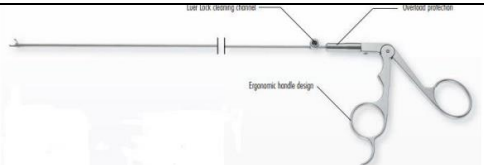
	<p>preensão de dupla ação, colher com dentes de jacaré, espiral distal flexível, espiral reta, mordedura horizontal, com orifício de limpeza, abertura da mandíbula de 90° 3,0 x 330 (mm)</p>		
--	---	---	--

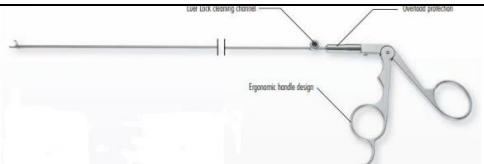
**Instrumentos com Ponta Distal Flexível (Cabo e Haste Completos)**

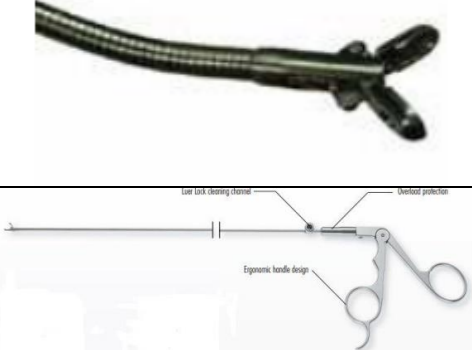
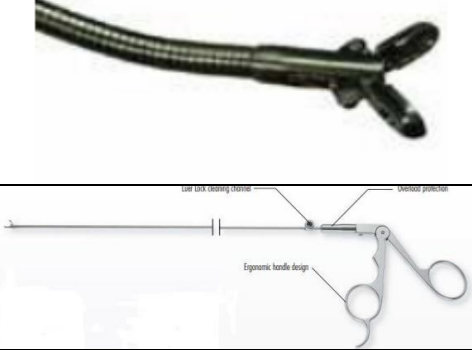

<p>SPFL7-25-33E</p>	<p>Instrumentos com ponta distal flexível Cabo E ( Pinça colher, ação simples, espiral distal flexível, espiral curva para cima, mordida vertical, com porta de limpeza, abertura da mandíbula de 90° 2,5 x 330 (mm)</p>	 	<p>AÇO INOX ASTM F899</p>
<p>SPFL7-30-33E</p>	<p>Instrumentos com ponta distal flexível Cabo E ( Pinça colher, ação simples, espiral distal flexível, espiral curva para cima, mordida vertical, com porta de limpeza, abertura da mandíbula de 90° 3,0 x 330 (mm)</p>	 	<p>AÇO INOX ASTM F899</p>



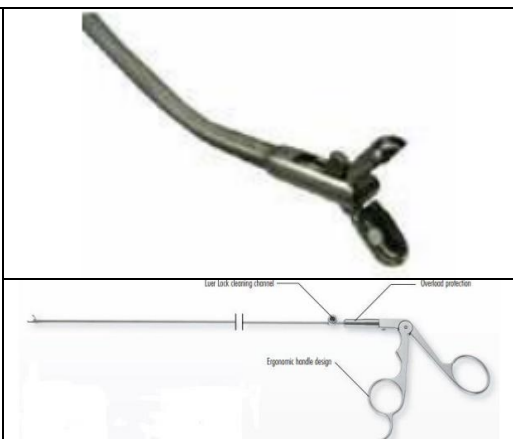



<p>SPFL8-25-33E</p>	<p>Instrumentos com ponta distal flexível Cabo E ( Pinça colher, dupla ação, espiral distal flexível, espiral curva para cima, mordida horizontal, com porta de limpeza, abertura da mandíbula 90º) 2,5 x 330 (mm)</p>		<p>AÇO INOX ASTM F899</p>
<p>SPFL8-30-33E</p>	<p>Instrumentos com ponta distal flexível Cabo E ( Pinça colher, dupla ação, espiral distal flexível, espiral curva para cima, mordida horizontal, com porta de limpeza, abertura da mandíbula 90º) 3,0 x 330 (mm)</p>		<p>AÇO INOX ASTM F899</p>
<p>SPFL9-25-33E</p>	<p>Instrumentos com ponta distal flexível Cabo E ( Pinça colher, dupla ação, espiral distal flexível, espiral reta, mordida horizontal, com porta de limpeza, abertura da mandíbula de 90º)</p>		<p>AÇO INOX ASTM F899</p>



	2,5 x 330 (mm)		
SPFL9-30-33E	Instrumentos com ponta distal flexível Cabo E ( Pinça colher, dupla ação, espiral distal flexível, espiral reta, mordida horizontal, com porta de limpeza, abertura da mandíbula de 90° 3,0 x 330 (mm)		AÇO INOX ASTM F899
			
SPFL10-25-33E	Instrumentos com ponta distal flexível Cabo E ( Pinça colher, dupla ação, espiral distal flexível, espiral curva para cima, mordida vertical, com porta de limpeza, abertura da mandíbula de 90° 2,5 x 330 (mm)		AÇO INOX ASTM F899
			

<p>SPFL10-30-33E</p>	<p>Instrumentos com ponta distal flexível Cabo E ( Pinça colher, dupla ação, espiral distal flexível, espiral curva para cima, mordida vertical, com porta de limpeza, abertura da mandíbula de 90° 3,0 x 330 (mm)</p>		<p>AÇO INOX ASTM F899</p>
----------------------	--	---	---------------------------

**Instrumentos com Haste Distal Flexível (Cabo e Haste Completos, com Cabo Galvanizado a Ouro)**

<p>SPFL7-25-33EGH</p>	<p>Instrumentos com ponta distal flexível Cabo E com ASTM B488 ( Pinça colher, ação simples, espiral distal flexível, espiral curva para cima, mordida vertical, com porta de limpeza, abertura da mandíbula de 90° 2,5 x 330 (mm)</p>		<p>AÇO INOX ASTM F899 E ASTM B488</p>
<p>SPFL7-30-33EGH</p>	<p>Instrumentos com ponta distal flexível Cabo E com ASTM B488 ( Pinça colher, ação simples, espiral distal flexível, espiral curva para cima, mordida vertical, com porta de limpeza, abertura da mandíbula de 90°)</p>		<p>AÇO INOX ASTM F899 E ASTM B488</p>

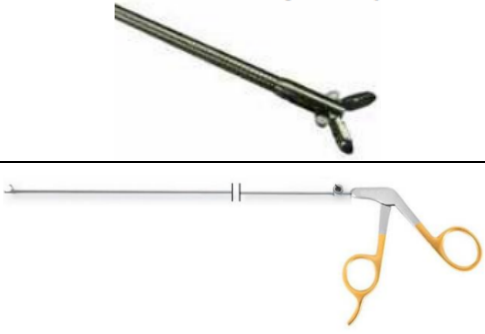
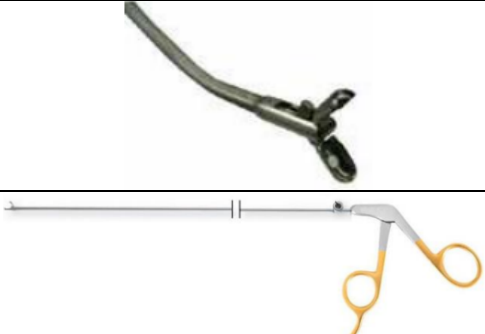
	3,0 x 330 (mm)		
SPFL8-25-33EGH	Instrumentos com ponta distal flexível Cabo E com ASTM B488 ( Pinça colher, dupla ação, espiral distal flexível, espiral curva para cima, mordida horizontal, com porta de limpeza, abertura da mandíbula 90º) 2,5 x 330 (mm)	 	AÇO INOX ASTM F899 E ASTM B488
SPFL8-30-33EGH	Instrumentos com ponta distal flexível Cabo E com ASTM B488 ( Pinça colher, dupla ação, espiral distal flexível, espiral curva para cima, mordida horizontal, com porta de limpeza, abertura da mandíbula 90º) 3,0 x 330 (mm)	 	AÇO INOX ASTM F899 E ASTM B488
SPFL9-25-33EGH	Instrumentos com ponta distal flexível Cabo E com ASTM B488 ( Pinça colher, dupla ação, espiral distal flexível, espiral reta, mordida horizontal, com porta de limpeza, abertura da mandíbula de 90º) 2,5 x 330 (mm)	 	AÇO INOX ASTM F899 E ASTM B488

SPFL9-30-33EGH	<p>Instrumentos com ponta distal flexível</p> <p>Cabo E com ASTM B488 ( Pinça colher, dupla ação, espiral distal flexível, espiral reta, mordida horizontal, com porta de limpeza, abertura da mandíbula de 90°)</p> <p>3,0 x 330 (mm)</p>		<p>AÇO INOX ASTM F899 E ASTM B488</p>
SPFL10-25-33EGH	<p>Instrumentos com ponta distal flexível</p> <p>Cabo E com ASTM B488 ( Pinça colher, dupla ação, espiral distal flexível, espiral curva para cima, mordida vertical, com porta de limpeza, abertura da mandíbula de 90°)</p> <p>2,5 x 330 (mm)</p>		<p>AÇO INOX ASTM F899 E ASTM B488</p>
SPFL10-30-33EGH	<p>Instrumentos com ponta distal flexível</p> <p>Cabo E com ASTM B488 ( Pinça colher, dupla ação, espiral distal flexível, espiral curva para cima, mordida vertical, com porta de limpeza, abertura da mandíbula de 90°)</p> <p>3,0 x 330 (mm)</p>		<p>AÇO INOX ASTM F899 E ASTM B488</p>

**Instrumentos com ponta distal flexível (peça completa, cabo e haste juntos)**

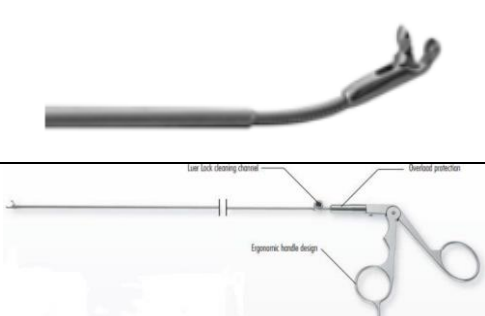

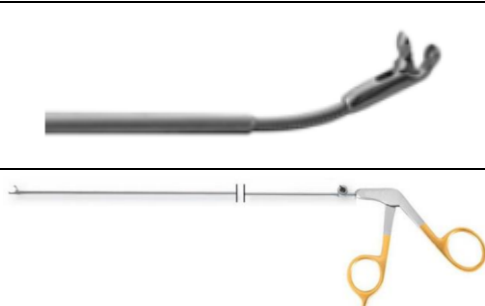

<p>SPFL12-25-33E</p>	<p>Instrumentos com ponta distal flexível Cabo E ( Pinça colher, mandíbula oval curta e afiada de 45°, ação única, espiral distal flexível, mordedura vertical, com porta de limpeza) 2,5 x 330 (mm)</p>		<p>AÇO INOX ASTM F899</p>
----------------------	--	---	---------------------------

**Instrumentos com Haste Distal Flexível (Cabo e Haste Completos com Cabo Galvanizado a Ouro)**

<p>SPFL12-25-33EGH</p>	<p>Instrumentos com ponta distal flexível Cabo E com ASTM B488 ( Pinça colher, mandíbula oval curta e afiada de 45°, ação única, espiral distal flexível, mordedura vertical, com porta de limpeza) 2,5 x 330 (mm)</p>		<p>AÇO INOX ASTM F899 E ASTM B488</p>
------------------------	--	---	---

**Instrumentos Rotativos em 360°**

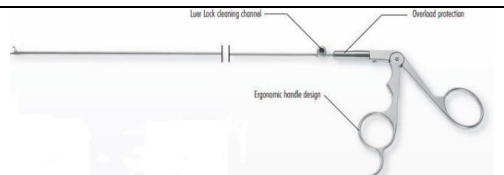

<p>SPL3-25-33R</p>	<p>Instrumentos rotativos 360° Cabo R ( Colher de mandíbula redonda, 45° para cima, corte, ação única) 2,5 x 330 (mm)</p>		<p>AÇO INOX ASTM F899</p>
--------------------	---	---	---------------------------

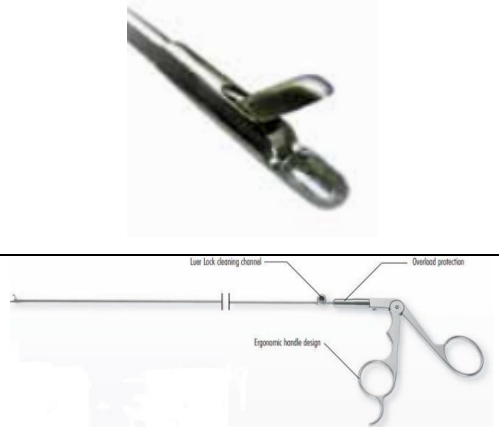
			
SPP1-25-33R	<p>Instrumentos rotativos 360°            Cabo R ( Punção Endo-Hook sem dente, mandíbula angulada de 15° para cima, punção com 1,2 mm, ação simples, abertura da mandíbula 90º)            2,5 x 330 (mm)</p>	 	AÇO INOX ASTM F899
SPL2-25-33R	<p>Instrumentos rotativos 360°            Cabo R( Colher de mandíbula redonda, corte, ação única, abertura da mandíbula 90º)            2,5 x 330 mm</p>	 	AÇO INOX ASTM F899

SPL1-27-33R	<p>Instrumentos rotativos 360° Cabo R (Colher longa oval para mandíbula, corte, ação única, abertura da mandíbula 90°) 2,7 x 330 (mm)</p>		AÇO INOX ASTM F899
-------------	---	---	--------------------

**Instrumentos Rotativos em 360° (Cabo e Haste Completos com Cabo Galvanizado a Ouro)**

SPL3-25-33RGH	<p>Instrumentos rotativos 360° Cabo R com ASTM B488 ( Colher de mandíbula redonda, 45° para cima, corte, ação única) 2,5 x 330 (mm)</p>		AÇO INOX ASTM F899 E ASTM B488
SPP1-25-33RGH	<p>Instrumentos rotativos 360° Cabo R com ASTM B488 ( Punção Endo-Hook sem dente, mandíbula angulada de 15° para cima, punção com 1,2 mm, ação simples, abertura da mandíbula 90°) 2,5 x 330 (mm)</p>		AÇO INOX ASTM F899 E ASTM B488

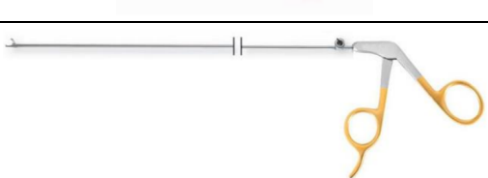
SPL2-25-33RGH	<p>Instrumentos rotativos 360° Cabo R com ASTM B488 ( Colher de mandíbula redonda, corte, ação única, abertura da mandíbula 90º) 2,5 x 330 mm</p>	 	<p>AÇO INOX ASTM F899 E ASTM B488</p>
SPL1-27-33RGH	<p>Instrumentos rotativos 360° Cabo R com ASTM B488 (Colher longa oval para mandíbula, corte, ação única, abertura da mandíbula 90º) 2,7 x 330 (mm)</p>	 	<p>AÇO INOX ASTM F899 E ASTM B488</p>



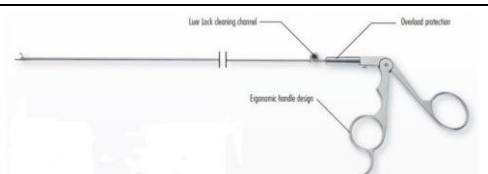

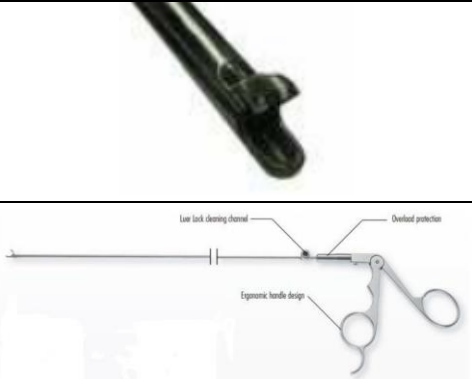
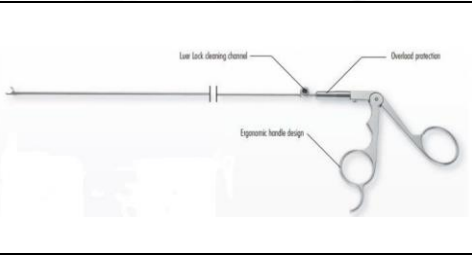
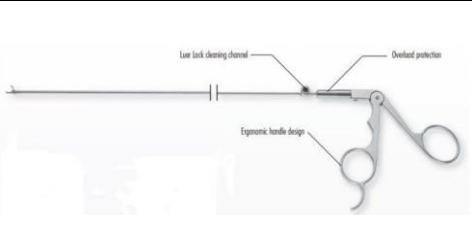
**Pinça para sucção**

SPP1-35-29S	<p>Pinça para sucção Cabo S ( Pinça com canal de sucção integrado) 3,5 x 290 (mm)</p>	 	<p>AÇO INOX ASTM F899</p>
-------------	---	--	---------------------------

SPP1-50-25S	<p>Pinça para sucção Cabo S ( Pinça com canal de sucção integrado) 5,0 x 250 (mm)</p>		AÇO INOX ASTM F899
SPP2-35-29S	<p>Pinça para sucção Cabo S ( Pinça de mordedura traseira com canal de sucção integrado) 3,5 x 290 (mm)</p>		AÇO INOX ASTM F899
SPP2-50-25S	<p>Pinça para sucção Cabo S ( Pinça de mordedura traseira com canal de sucção integrado) 5,0 x 250 (mm)</p>		AÇO INOX ASTM F899

**Pinça para sucção (Cabo e Haste Completos com Cabo Galvanizado a Ouro)**





SPP1-35-29SGH	<p>Pinça por sucção Cabo S com ASTM B488 ( punção com canal de sucção integrado) 3,5 x 290 (mm)</p>		AÇO INOX ASTM F899 E ASTM B488
---------------	---	---	-----------------------------------





			
SPP1-50-25SGH	Pinça por sucção Cabo S com ASTM B488 ( punção com canal de sucção integrado) 5,0 x 250 (mm)	 	AÇO INOX ASTM F899 E ASTM B488
SPP2-35-29SGH	Pinça por sucção Cabo S com ASTM B488 ( Punção de mordedura traseira com canal de sucção integrado) 3,5 x 290 (mm)		AÇO INOX ASTM F899 E ASTM B488
SPP2-50-25SGH	Pinça por sucção Cabo S com ASTM B488 ( Punção de mordedura traseira com canal de sucção integrado) 5,0 x 250 (mm)		AÇO INOX ASTM F899 E ASTM B488





### Pinça Endo-Kerrison Rotativa

SPPR4-35-330	Pinça Endo-Kerrison Rotativa ( Aplicação de pinça Endo-Kerrison 40°, abertura de 14 mm)		AÇO INOX ASTM F899
--------------	---	---	--------------------

	3,50 x 330 (mm)		
SPPR9-35-330	Pinça Endo-Kerrison Rotativa ( Aplicação de pinça Endo-Kerrison 90°, abertura de 14 mm) 3,5 x 330 (mm)	 	AÇO INOX ASTM F899
SPPR4-TPC	Pinça Endo-Kerrison Rotativa ( Aplicação de pinça Endo-Kerrison 40°, abertura de 14 mm) 3,50 x 330 (mm)		AÇO INOX ASTM F899
SPPR9-TPC	Pinça Endo-Kerrison Rotativa ( Aplicação de pinça Endo-Kerrison 90°, abertura de 14 mm) 3,5 x 330 (mm)		AÇO INOX ASTM F899
SPP4D-30-350	Pinça Endo-Kerrison ( Altura e largura da pinça 3 x 350 mm, 40°)		AÇO INOX ASTM F899









SPP4D-35 350	Pinça Endo-Kerrison ( Altura e largura da pinça 3,5 x 350 mm, 40º)		AÇO INOX ASTM F899
SPP9D-30-350	Pinça Endo-Kerrison ( Altura e largura da pinça 3 x 350 mm, 90º)		AÇO INOX ASTM F899
SPP9D-35-350	Pinça Endo-Kerrison ( Altura e largura da pinça 3,5 x 350 mm, 90º)		AÇO INOX ASTM F899
SPP4D-30-TPC	Pinça Endo-Kerrison ( Altura e largura da pinça 3 x 350 mm, 40º)		AÇO INOX ASTM F899
SPP4D-35 TPC	Pinça Endo-Kerrison ( Altura e largura da pinça 3,5 x 350 mm, 40º)		AÇO INOX ASTM F899

SPP9D-30-TPC	Pinça Endo-Kerrison ( Altura e largura da pinça 3 x 350 mm, 90º)		AÇO INOX ASTM F899
SPP9D-35-TPC	Pinça Endo-Kerrison ( Altura e largura da pinça 3,5 x 350 mm, 90º)		AÇO INOX ASTM F899
SPPD-20-270	Pinça Estenose - Kerrison ( Altura e largura da pinça 2 x 270 mm)		AÇO INOX ASTM F899
SPPD-30-270	Pinça Estenose - Kerrison ( Altura e largura da pinça 3 x 270 mm)		AÇO INOX ASTM F899
SPPD-40-270	Pinça Estenose - Kerrison ( Altura e largura da pinça 4 x 270 mm)		AÇO INOX ASTM F899

SPPD-50-270	Pinça Estenose - Kerrison ( Altura e largura da pinça 5 x 270 mm)		AÇO INOX ASTM F899
SPPD-20-TPC	Pinça Estenose - Kerrison ( Altura e largura da pinça 2 x 270 mm)		AÇO INOX ASTM F899
SPPD-20-TPC	Pinça Estenose - Kerrison ( Altura e largura da pinça 3 x 270 mm)		AÇO INOX ASTM F899
SPPD-20-TPC	Pinça Estenose - Kerrison ( Altura e largura da pinça 4 x 270 mm)		AÇO INOX ASTM F899
SPPD-20-TPC	Pinça Estenose - Kerrison ( Altura e largura da pinça 5 x 270 mm)		AÇO INOX ASTM F899

### Drills Endo- Spine ajustável com broca ou trefina



O cabo redondo e a alça de engate podem ser ajustáveis com broca ou trefina, conforme ilustração abaixo.

SPB-HKR	Cabo redondo Alça de Engate com Punho de Esfera de Aço Inoxidável	 (01 un)	AÇO INOX ASTM F899
SPB-HKA	Alça de Engate com Punho de Silicone Azul	 (01 un)	AÇO INOX ASTM F899 Silicone grau médico
SPB-38	Broca Ø3,8mm	 (01 un)	AÇO INOX ASTM F899
SPB-58	Broca Ø5,8mm	 (01 un)	AÇO INOX ASTM F899
SPB-68	Broca Ø6,8mm	 (01 un)	AÇO INOX ASTM F899
SPB-78	Broca Ø7,8mm	 (01 un)	AÇO INOX ASTM F899
SPB-88	Broca Ø8,8mm	 (01 un)	AÇO INOX ASTM F899
STT-60	Trefina Ø6,0 mm	 (01 un)	AÇO INOX ASTM F899

STT-70	Trefina Ø7,0 mm		AÇO INOX ASTM F899
STT-80	Trefina Ø8,0 mm		AÇO INOX ASTM F899
STT-90	Trefina Ø9,0 mm		AÇO INOX ASTM F899

**Trefina com cabo em U**

A trefina com cabo em formato de U pode apresentar modelos com pontas de diâmetros diferentes.

	Trefina		AÇO INOX ASTM F899
ST-60	Trefina Ø6,0 mm (6,0 x 270 mm)		AÇO INOX ASTM F899





ST-70	Trefina Ø7,0 mm (7,0 x 270 mm)		AÇO INOX ASTM F899
ST-80	Trefina Ø8,0 mm (8,0 x 270 mm)		AÇO INOX ASTM F899
ST-90	Trefina Ø9,0 mm (9,0 x 270 mm)		AÇO INOX ASTM F899

**Fio-guia Kirschner**



SDW-10	Fio- Guia (2,5 x 230 mm)		AÇO INOX ASTM F899
--------	-----------------------------	---	--------------------

**Dilatadores, tubo cônico**



SD-40-190	Dilator, tubo cônico ( 4 x 190 mm)		AÇO INOX ASTM F899
-----------	---------------------------------------	---	--------------------





SD-50-170	Dilator, tubo cônico ( 5 x 170 mm)		AÇO INOX ASTM F899
SD-60-160	Dilator, tubo cônico ( 6 x 160 mm)		AÇO INOX ASTM F899
SD-63-210	Dilator, tubo cônico ( 6,3 x 210 mm)		AÇO INOX ASTM F899
SD-4-220	Dilator, tubo cônico (5-4 x 220 mm), curvado 10°		AÇO INOX ASTM F899

**Dilatadores, Empurrador de Haste**

SD-25-230	Dilator, empurrador de haste (2,5 x 230 mm)		AÇO INOX ASTM F899
SD-40-230	Dilator, empurrador de haste (4,0 x 230 mm)		AÇO INOX ASTM F899
SD-50-230	Dilator, empurrador de haste (5,0 x 230 mm)		AÇO INOX ASTM F899

**Tubos de Trabalho**

MP-89428-WT	Janela Oblíqua		AÇO INOX ASTM F899
			
MP-89429-WT	Ponta Elevadora		AÇO INOX ASTM F899

			
MP-89430-WT	Tubo de Proteção		AÇO INOX ASTM F899
			
MP-89431-WT	Tubo de Proteção com dentes		AÇO INOX ASTM F899
			







### **Tucho**





STP-28	Tucho (280 mm)		AÇO INOX ASTM F899
--------	-------------------	---	--------------------



### **Marreta**

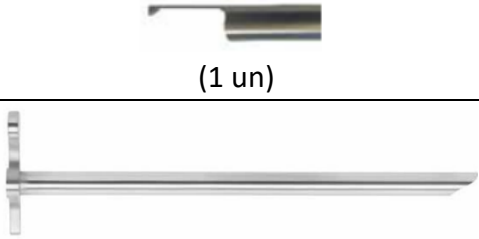



M-19	Marreta 195 (mm)		AÇO INOX ASTM F899 e Poliuretano (PU)
------	---------------------	---	--



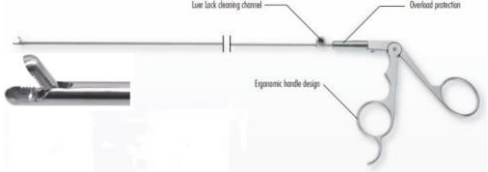
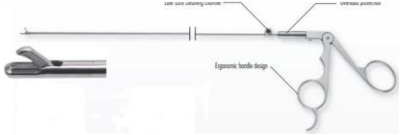
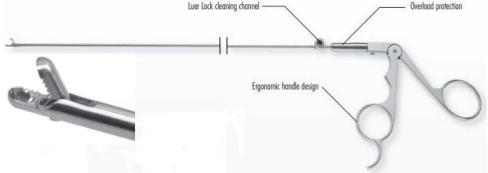

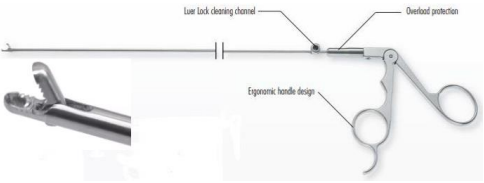
**Componentes do Conjunto Endo-Spine**

MP-5801T	Dilatador		AÇO INOX ASTM F899
MP-5802T	Cânula espiral, oblíqua  (13,7 x 85mm)	 (1 un)	AÇO INOX ASTM F899
			
MP-5803T	Cânula espiral, plana  (13,7 x 85mm)	 (1 un)	AÇO INOX ASTM F899
			
MP-5804T	Cânula bico de pato 30 mm  (6 x 231mm)	 (1 un)	AÇO INOX ASTM F899
			

MP-5805T	<p>Cânula bico de pato 30 mm</p> <p>(6 x 231mm)</p>	 <p>(1 un)</p>	AÇO INOX ASTM F899
MP-5807T	<p>Elevador</p> <p>(2,5 x 320 mm)</p>		AÇO INOX ASTM F899
MP-5808T	<p>Gancho para nervo</p> <p>(3x320 mm)</p>	 <p>(1 un)</p>	AÇO INOX ASTM F899
MP-5809T	<p>Cureta</p> <p>( 4,5 x 260 mm)</p>	 <p>( 1 un)</p>	AÇO INOX ASTM F899
MP-5810T	<p>Elevador</p> <p>(4,5 x 260 mm)</p>	 <p>(1 un)</p>	AÇO INOX ASTM F899

MP-5811T	<p>Osteótomo</p> <p>(3,5 x 240 mm)</p>		AÇO INOX ASTM F899
MP-5813T	<p>Cânula de Trabalho</p> <p>(11,2 x 117 mm) (45° oblíqua)</p>	 <p>(1 un )</p>	AÇO INOX ASTM F899
MP-5820T	<p>Corpo estranho de núcleo fórceps</p> <p>Ação simples</p> <p>(4,5 x 240 mm)</p>	 <p>(1 un)</p>	AÇO INOX ASTM F899
MP-5824T	<p>Fórceps de Punção</p> <p>(4,5 x 240 mm)</p>	 <p>(1 un)</p>	AÇO INOX ASTM F899
MP-5833T	<p>Fórceps para biópsia</p> <p>( 3,5 x240 mm)</p>	 <p>(1 un)</p>	AÇO INOX ASTM F899

MP-5833.1T	<p>Fórceps para biópsia</p> <p>( 2,7 x 270 mm)</p>	 <p>(1 un)</p>	AÇO INOX ASTM F899
MP-5030.6T	<p>Rouneur</p> <p>(3,5 x 15x 270 mm)</p> <p>(Largura da cabeça 1,5 mm)</p>	 <p>(1 un )</p>	AÇO INOX ASTM F899
MP-5030.7T	<p>Rouneur</p> <p>(4,0 x 15x 240 mm)</p> <p>(Largura da cabeça 1,7 mm)</p>	 <p>(1 un)</p>	AÇO INOX ASTM F899
MP-5030.8T	<p>Rouneur</p> <p>(5,5 x 15x 240 mm)</p> <p>(Largura da cabeça 2,5 mm)</p>	 <p>(1 un)</p>	AÇO INOX ASTM F899
MP-5030.9T	<p>Rouneur</p> <p>(5,5 x 15x 240 mm)</p> <p>(Largura da cabeça 2,5 mm)</p>	 <p>(1 un)</p>	AÇO INOX ASTM F899

<p>MP- 5030.10T</p>	<p>Rouneur (6,0 x 270 mm) (Largura da cabeça 2,2 mm) 45°</p>	 (1 un)	<p>AÇO INOX ASTM F899</p>
<p>MP- 5030.11T</p>	<p>Rouneur (6,0 x 270 mm) (Largura da cabeça 3,2 mm) 45°</p>	 (1 un)	<p>AÇO INOX ASTM F899</p>
<p>MP- 5030.12T</p>	<p>Rouneur (6,0 x 270 mm) (Largura da cabeça 4,0 mm) 45°</p>	 (1 un)	<p>AÇO INOX ASTM F899</p>
<p>MP- 5030.13T</p>	<p>Rouneur (6,0 x 270 mm) (Largura da cabeça 3,2 mm) 15°</p>	 (1 un)	<p>AÇO INOX ASTM F899</p>
<p>MP-1001- ATH</p>	<p>Adaptador Cabo-T</p>	 (1 un)	<p>AÇO INOX ASTM F899</p>



Belizete Lobato Cruz  
Responsável Legal

Diana Carvalho de Alencar  
Responsável Técnico  
COREN/CE: 9112-ENF